



"The Fold-Away Workbench"

Owner's Manual

& Assembly Instructions

PATENT PENDING

Bench Solution™ Fold Down Work Bench

Model QW00

(Equipped with IdealWall wall panel)

Model QW01 (does not include wall panel)



IF ASSISTANCE WITH INSTALLATION IS NEEDED

DO NOT CONTACT THE STORE!!!

Hire a professional contractor or

CALL OUR CUSTOMER SERVICE DEPARTMENT at:

(1-866-223-6247)

Hours: 8:00am to 5:00pm Monday through Friday Central Time

Call or visit our web site

www.BenchSolution.com

Table of Contents:

| | |
|---------------------------------------|-------|
| Introduction | 2 |
| Safety Instructions | 3 |
| Weight Capacity..... | 3 |
| Tools Needed | 3 |
| Unpacking Instructions | 3 |
| Hardware Identifier & Parts List..... | 4,5,6 |
| Safety Instructions..... | 7 |
| Assembly Instructions..... | 7 |
| IdealWall™ Weight Capacity..... | 13 |
| Operating Instructions | 14 |
| System Maintenance | 15 |
| Warranty Information | 15 |
| Contact Information | 15 |

Introduction:

Thank you for purchasing Bench Solution™ fold down work bench. Our **Patent Pending** design will provide a safe and durable fold down work station. With proper installation and maintenance your bench will provide you with a sturdy and spacious work station without taking up valuable floor space.

Important Safety Instructions



Warning



To Reduce the Risk of Severe Injury or Death

1. READ AND FOLLOW ALL INSTRUCTIONS
2. NEVER allow children to operate or play on or around bench.
3. NEVER place more than rated weight capacity on bench or tool storage panels.
4. ALWAYS maintain and care for system as instructed.
5. NEVER operate unless bench is properly installed and secured to wood studs.
6. SAVE THESE INSTALLATION INSTRUCTIONS.



This is a safety alert symbol. It is used to alert you to potential personal injury hazards. Obey all safety messages that follow this symbol to avoid possible injury or death.



WARNING: To ensure your safety, do not attempt to assemble this system without reading and following all instructions carefully. Identify, inventory, and sort parts using parts list. Failure to comply with any warnings or instructions may result in serious personal injury. If you do not feel you are qualified to install bench properly, you must hire a professional contractor!!!

Bench Weight Capacity: 400 lbs. This refers to a static load of 400 lbs. evenly distributed over the surface of the wooden top. It is the maximum amount of weight the work bench was designed to safely support after it is mounted to wood wall studs. *

The Bench Solution™ fold down work bench is engineered and designed for residential use. The work bench has a static load capacity of 400 lbs evenly distributed over the surface of the wooden top. To avoid damage or injury, the weight limit must not be exceeded. Any other use is not recommended and voids any liability by manufacturer.

This work bench is designed and tested to offer safe service if it is installed, operated and maintained in strict accordance with instructions and warnings contained in this manual.

TOOLS AND MATERIALS NEEDED

5/32" drill bit and 7/32" Allen Wrench (Included in fastener package)
Allen Wrench is required to tighten fasteners 17, 18, 19. Drill bit is required to pre-drill holes for item 20.

Required for Assembly (Not Included)

| | | |
|--------------|---------------------|--------------------------|
| Drill | Level | Stud Finder |
| Square | 9/16" wrench | Pencil |
| Tape Measure | 9/16" & 3/8" socket | Awl (sm. finishing nail) |







UNPACKING INSTRUCTIONS:



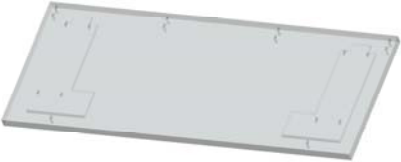

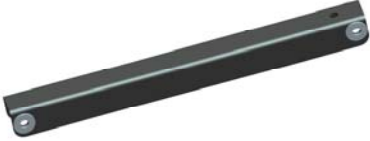

Separate all parts from packaging materials and check each item with parts list found on pages 4,5,& 6. If any parts or fasteners are missing do not proceed with assembly and contact Bench Solution immediately. 1-866-223-6247.

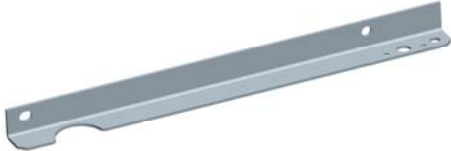

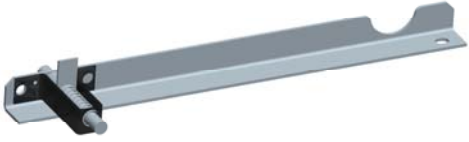
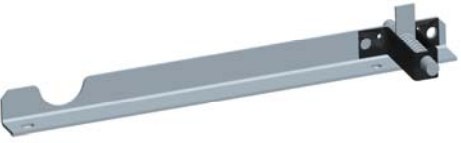











Make sure **all** items are accounted for before discarding any packing materials.

* For alternate mounting methods go to www.BenchSolution.com or call 1-866-223-6247

HARDWARE IDENTIFIER & PARTS LIST

| ID | PART# | DESCRIPTION | QTY | ✓ | VISUAL Illustrations are for visual purposes only and do not represent actual size or color of parts or fasteners. |
|----|----------|-------------------------|-----|---|---|
| 1 | BS000058 | Hardwood Top | 1 | |  |
| 2 | BS000075 | Hinge | 3 | |  |
| 3 | BS000077 | Horizontal Wall Bracket | 1 | |  |
| 4 | BS000059 | Vertical Wall Brackets | 2 | |  |
| 5 | BS000040 | Lower Leg Assembly | 2 | |  |
| 6 | BS000041 | Upper Leg Assembly | 2 | |  |
| 7 | BS000079 | Right Frame | 1 | |  |
| 8 | BS000080 | Left Frame | 1 | |  |

| ID | PART# | DESCRIPTION | QTY | ✓ | VISUAL Illustrations are for visual purposes only and do not represent actual size or color of parts or fasteners. |
|------------------|--------------------------|----------------------|-----|---|---|
| 9 | BS000108 | Right Frame w/safety | 1 | |  |
| 10 | BS000107 | Left Frame w/safety | 1 | |  |
| 11 | BS000105 | Right Handle | 1 | |  |
| 12 | BS000106 | Left Handle | 1 | |  |
| FASTENERS | | | | | |
| 13 | BS000112 (Model QW00) | Wall Panel Fastener | 40 | |  |
| 14 | BS000061 | 3/8 x 2 1/2" Bolt | 2 | |  |
| 15 | BS000062 | 3/8 x 3" Bolt | 2 | |  |
| 16 | BS000063 | 3/8 x 3 3/8" Bolt | 2 | |  |
| | | | | | |

| ID | PART# | DESCRIPTION | QTY | ✓ | VISUAL Illustrations are for visual purposes only and do not represent actual size or color of parts or fasteners. |
|----|--------------------------|---|-----|---|---|
| 17 | BS000064 | 3/8 x 2 1/4" Flat Head Screw | 6 | |  |
| 18 | BS000065 | 3/8 x 1 1/2" Flat Head Screw | 8 | |  |
| 19 | BS000066 | 3/8 x 3 1/4" Flat Head Screw | 2 | |  |
| 20 | BS000067 | Hex Head Lag Screw | 8 | |  |
| 21 | BS000068 | Self-lock Hex Nut | 24 | |  |
| 22 | BS000070 | 3/8" Flat Washer | 8 | |  |
| 23 | BS000110 | 1/4 " Flat Washer | 8 | |  |
| 24 | BS000071 | 1/2" x 9/16" Hex Bolt | 2 | |  |
| 25 | BS000086 | Handle Spacer | 2 | |  |
| 26 | BS000088 | End Cap for Wall Bracket | 2 | |  |
| 27 | BS000087 (Model QW00) | Wall Panel | 3 | |  |
| 28 | BS000111 (Model QW00) | Wall Panel Trim | 2 | |  |
| 29 | BS000113 | 7/32" Allen Wrench (used to tighten 17,18,&19) | 1 | |  |
| 30 | BS000114 | 5/32" drill bit. Use to pre-drill holes for item 20 | 1 | |  |



Safety Instructions

FAILURE TO READ AND FOLLOW INSTRUCTIONS MAY RESULT IN SERIOUS INJURY OR PROPERTY DAMAGE AND WILL VOID WARRANTY.

Owner must ensure that bench hardware remains secure for safe and proper operation of bench folding mechanism.

To ensure safety, do not attempt to assemble this system without reading and following instructions carefully. Check entire box and inside all packing material for parts and/or additional instruction material. Proper and complete assembly is essential for proper installation and will reduce risk of accident or injury. A high probability of risk or injury exists if system is not installed, maintained and operated properly.

Most injuries are caused by misuse and/or not following instructions.

ASSEMBLY INSTRUCTIONS

BEFORE BEGINNING ASSEMBLY

Identify and inventory all parts using checklist on parts lists. If any parts are missing, call Customer Service Department before proceeding with installation.



WARNING: This workbench is to be securely mounted to wood wall studs * on a flat vertical wall with properly spaced wood wall studs.* The wood wall studs * must be capable of supporting significant weight and be able to accommodate the Fold Away Workbench.

Stud spacing must be 16" or 24" stud center. Horizontal Wall Bracket has mounting 4 holes to accommodate 16" and 3 holes to accommodate 24" spacing. Illustrations show views of wood wall studs * for visual purposes only. Bench can be mounted to wood studs * in a finished wall.

Bench is only warranted if properly mounted to **wooden wall studs** * with hardware provided. Any other assembly not covered in these instructions or alternate instructions provided on web-site is considered a custom installation and therefore relieves the manufacturer of any liability of injury.

Read and Understand all Instructions, Notes, Warnings and Cautions before Beginning

* For alternate mounting methods go to www.BenchSolution.com or call 1-866-223-6247

Step 1

Determine desired height of workbench surface on wall (approximately 36" to 39" from the floor). Mark desired height on wall to designate placement of Horizontal Wall Bracket 3 (mounting holes will be approximately $\frac{3}{4}$ inch lower than desired surface height). Use a stud finder to locate wood wall studs * and mark locations. It is recommended that you use an awl or a finishing nail to ensure stud location. Pre-drill holes into stud center using $\frac{5}{32}$ " drill bit. Locate Horizontal Wall Bracket 3, add end caps 26, and secure into wood studs * using 20 and 23, **taking care to level bracket.** **If Horizontal Wall Bracket is not level the leg assembly will not operate properly.**

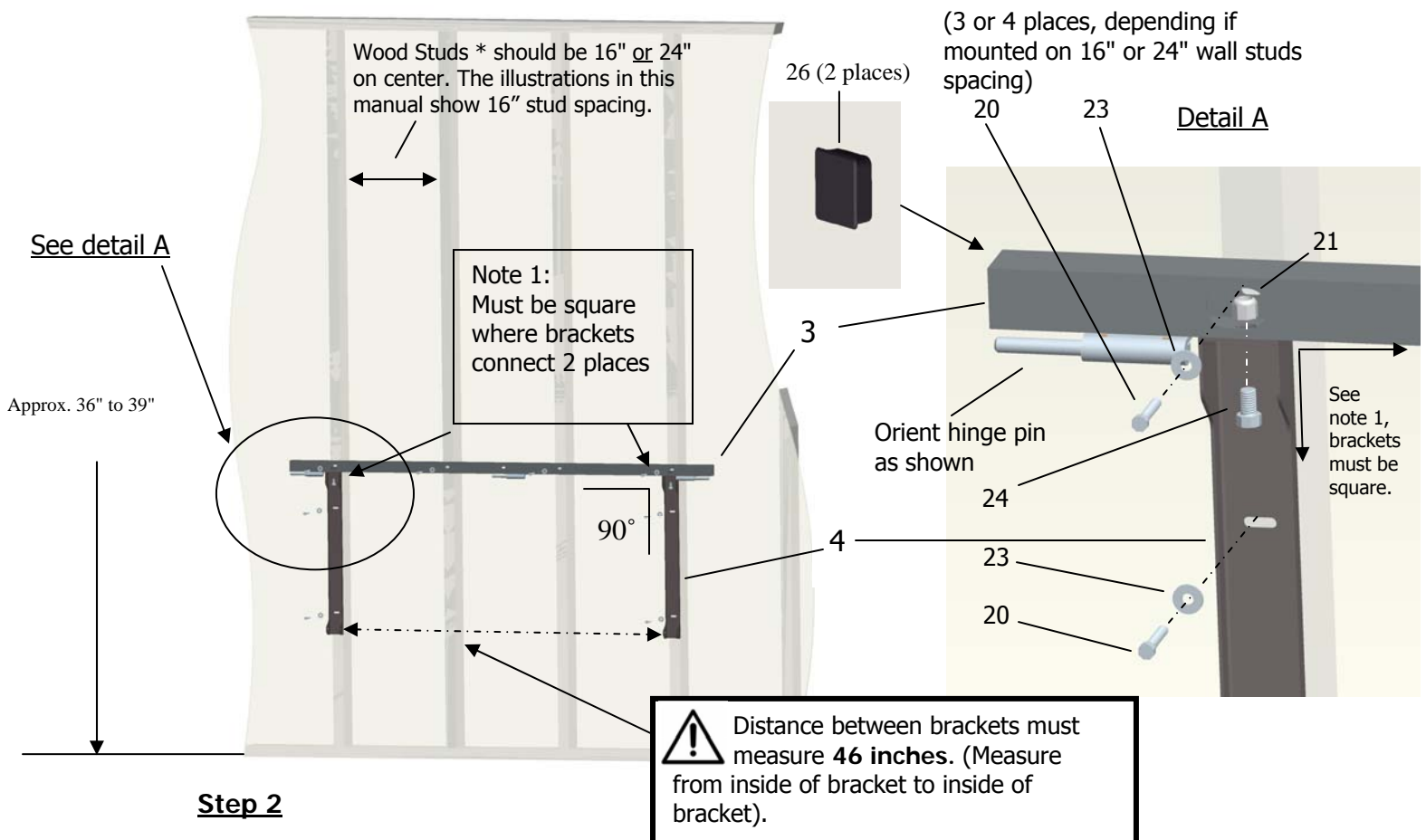

Step 2

Locate Vertical Wall Brackets 4 and attach to horizontal wall bracket using 21 and 24 as shown in Detail A. Do not fully tighten nut until hardware attaching the bracket into the wood wall studs * is in place and bracket is positioned vertically. Pre-drill holes in studs. Secure brackets to wood wall stud * using 20 and 23, **two places per bracket**. Tighten all hardware including 24 and 21.

Note 1: Vertical Wall Brackets must be aligned in a vertical position and square with Horizontal Wall Bracket to ensure Leg Assembly Operates Properly.

* For alternate mounting methods go to www.BenchSolution.com or call 1-866-223-6247

Step 3

Locate lower leg assembly 5. Orient lower leg assembly as shown in Detail B, attach to vertical wall bracket using 14 and 21. Attach remaining lower leg assembly by repeating this step. Fasteners must be oriented as shown. The nut must be inserted from "inside" of bench on both legs.

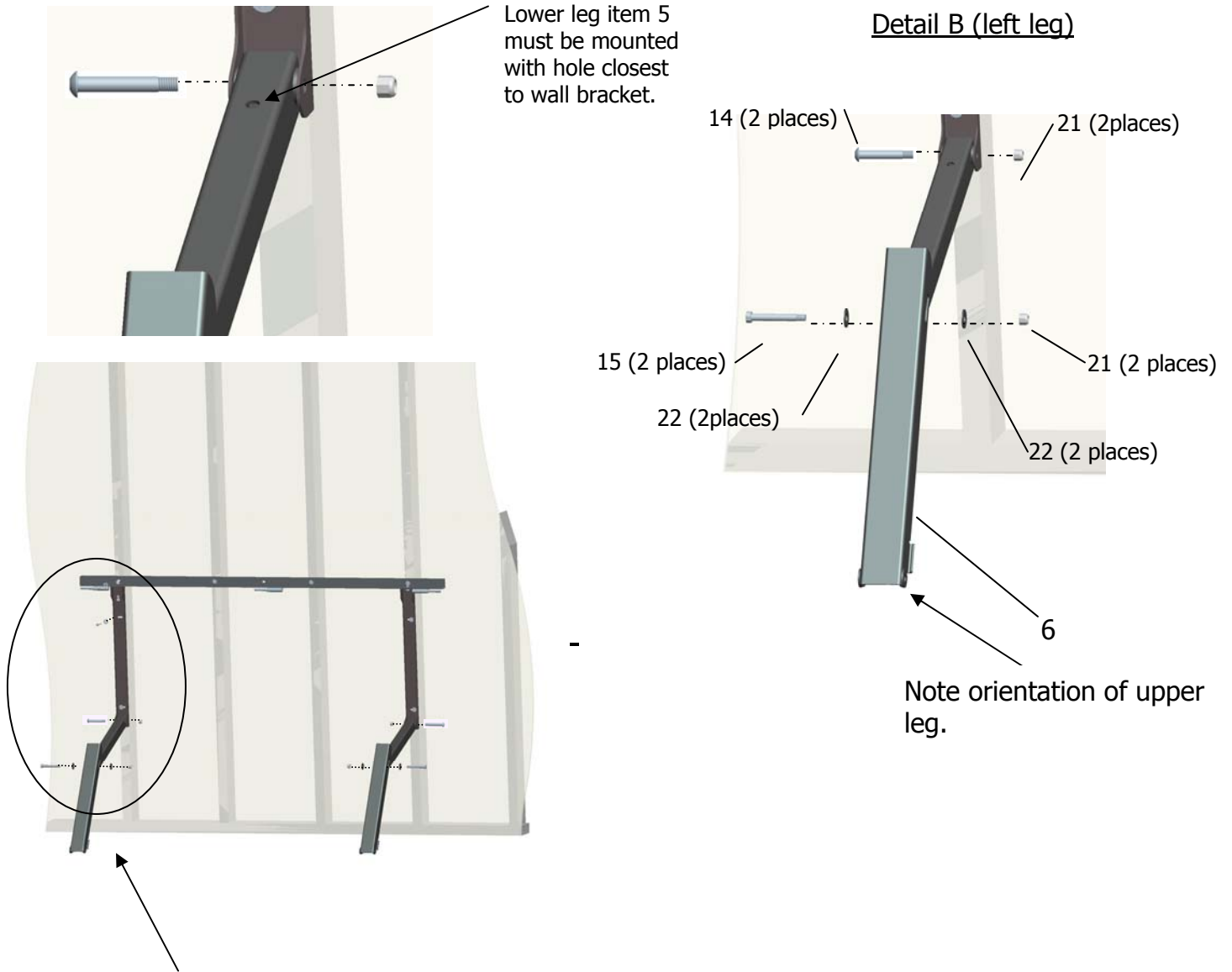

Locate the upper leg 6 and orient as shown in Detail B. Line up mounting holes as shown with lower leg resting in upper leg. Attach upper leg to lower leg using 15, 21 and 22. *Leg assembly to remain unattached from wood top until after Step 6.*

Step 4

Locate wooden top 1. Attach two hinges 2 to top where shown using 17 and 21. The third hinge is used as a "locking" hinge and will be fastened after top is mounted to wall bracket. Attach frames 7, 8, 9, and 10 to wood top as shown using 18 and 21. Parts are not interchangeable and must be oriented as shown. Attach handles as shown in Detail C & D.

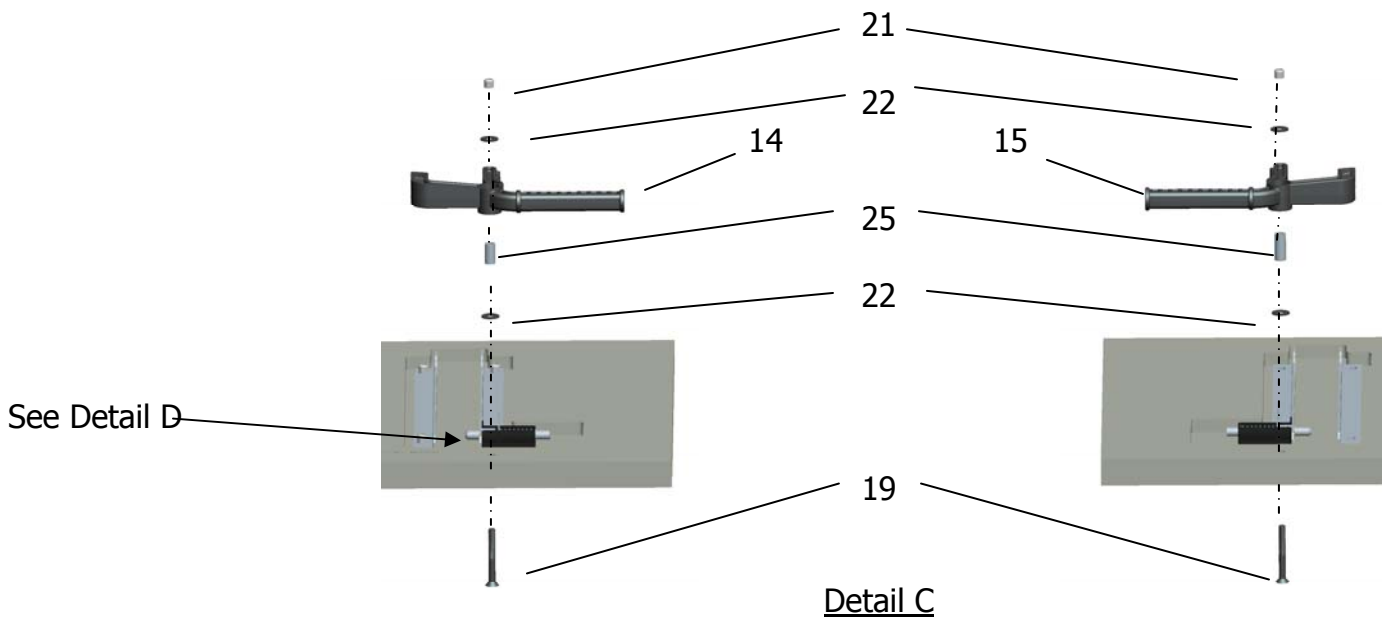
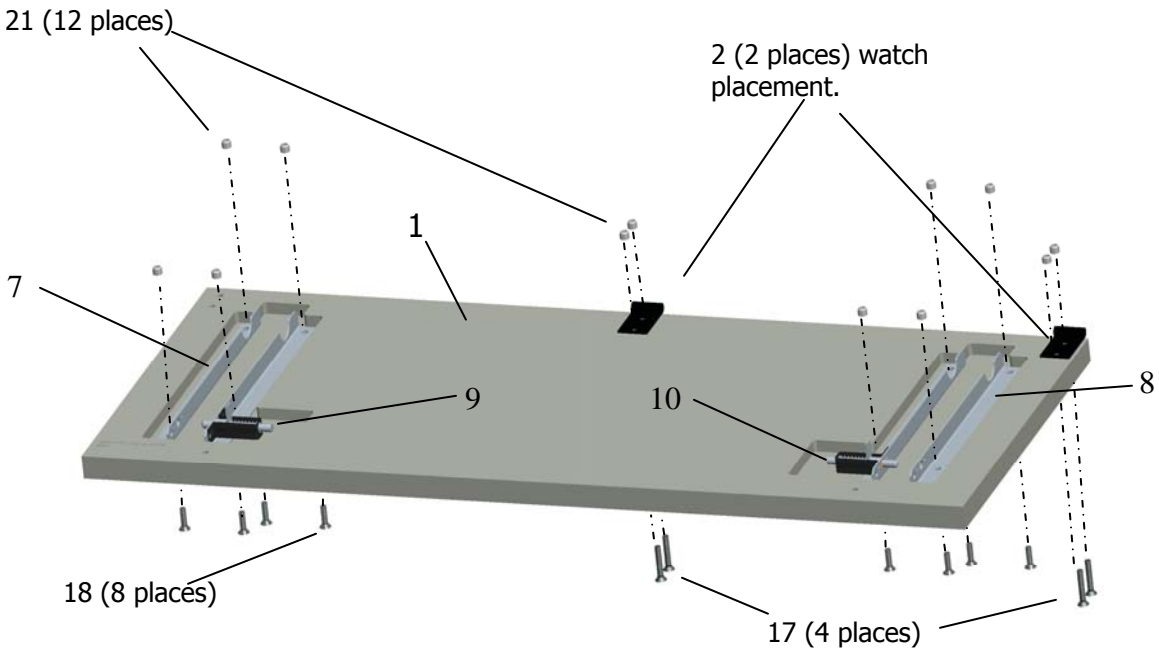

When mounting handles, retract safety pin to allow handle to rest between frame and pin plate.

Detail D

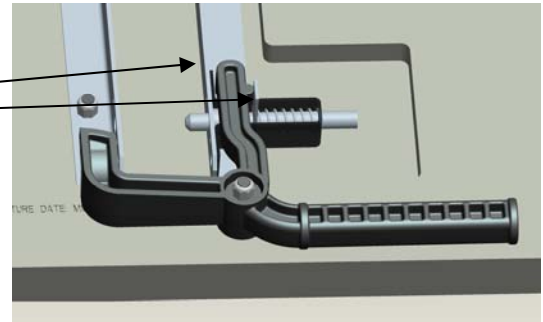

Step 5

Attach top to Horizontal Wall Bracket by sliding hinges into place. Wood top weighs approximately 46 lbs. (For ease of assembly it is recommended that two adults perform this step).

Align hinges with hinge pins and slide into place.



Warning: During assembly and after completed assembly these locations will create pinch points when lowering bench top into fold down position. To avoid injury clear these areas before performing this operation.

Step 6

Slide locking hinge 2 on to hinge pin and secure into place using 17 and 21.

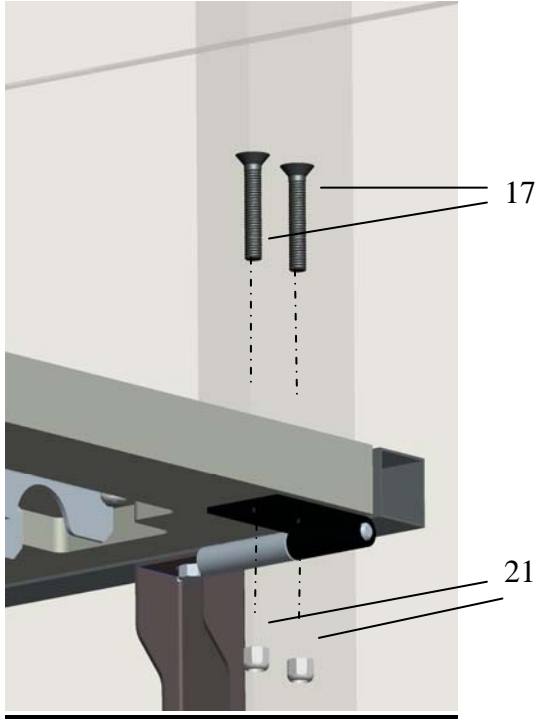

Step 7

Attach leg assembly to bench top by first supporting bench top in an upright position away from wall. Align mounting holes on upper leg with mounting holes in frames. (Depending on position of bench top, you may have to retract safety pin to provide clearance for leg). Secure leg assembly to frame using 16 and 21. Repeat this step with remaining leg.

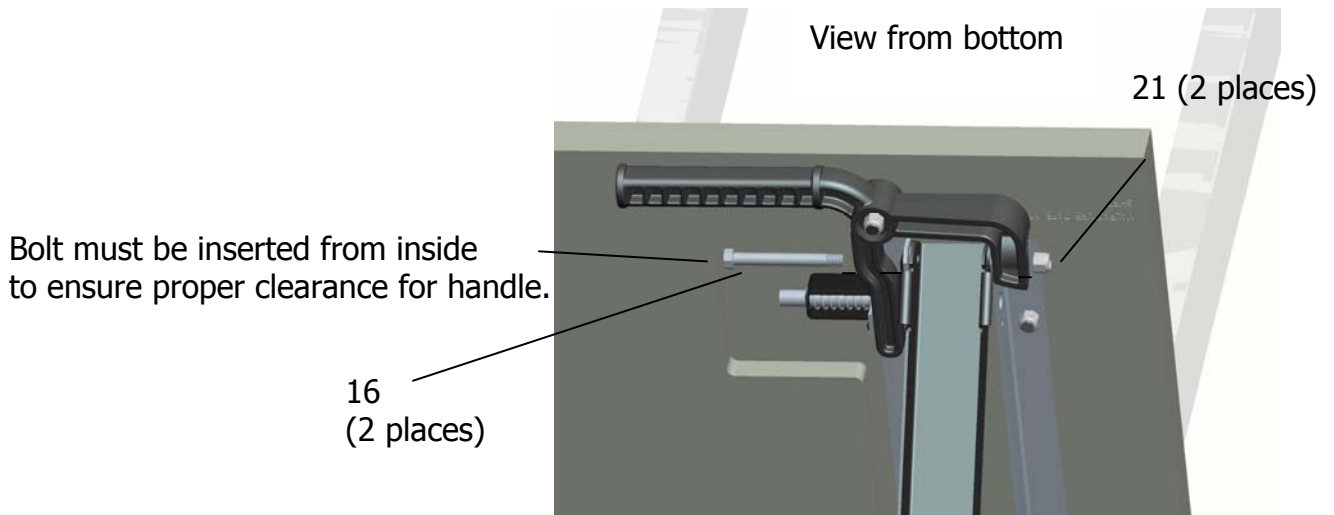

Step 8 (Model QW00 includes wall panel)

If you are installing Model QW01 proceed to page 14 operating instructions.

Locate IdealWall™ panels 27 and position each unit above bench, orient as shown in Detail E and secure into place, driving fastener 13 into wood studs.* For maximum load capacity, secure each panel using 12 fasteners per unit.

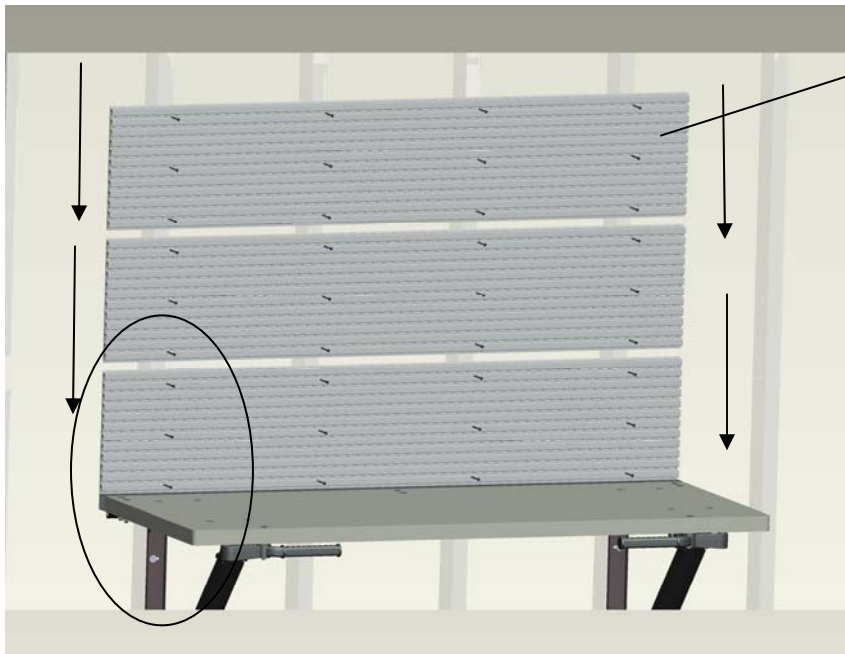

IdealWall™ is designed to support standard hand tools. Hanging objects heavier than suggested, will result in damage of material and could cause injury, and will void manufacturer warranty. For maximum load capacity drive all fasteners into wood studs* as shown in illustrations.

See Detail E (Side view)

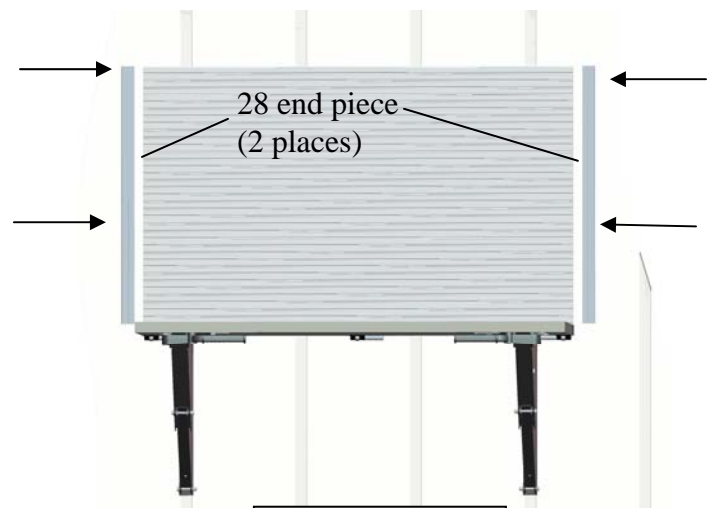
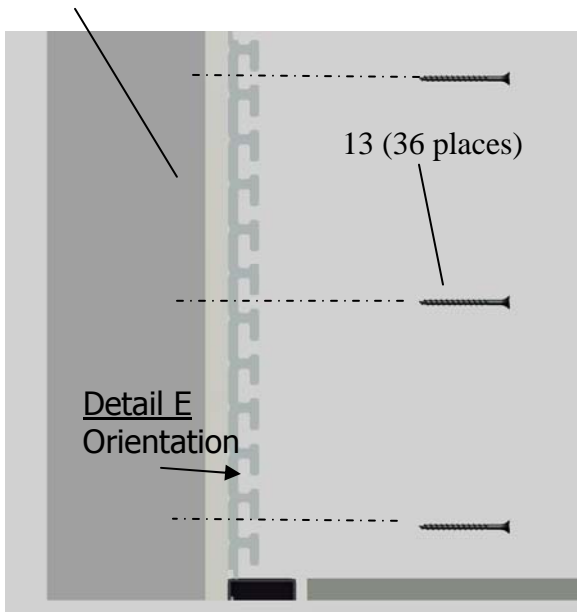

* For alternate mounting methods go to www.BenchSolution.com or call 1-866-223-6247

Operating instructions:



Failure to follow operation instructions can cause death or injury!!

To lower bench into fold down position:

1. Ensure bench top is clear of any items.
2. Ensure area below bench is clear of people, pets and property.
3. Stand in front of bench and be prepared to support the 46 lb. hardwood top. **CAUTION: Do not allow bench to free fall to wall.**
4. Grasp both handles simultaneously, pull towards you. This action allows safety pins to clear frames, legs will buckle to allow bench to be lowered into fold down position. **WARNING:** This action creates pinch points. Lower top gradually.

To raise bench to upright position:

WARNING: Legs contain pinch points.

1. Stand in front of bench, grasp bench top and lift top into upright horizontal position until legs lock securely into place.
2. **WARNING:** Check to ensure legs are fully locked and safety pins are in place before using bench.

When properly mounted to wood wall studs,* Bench Solution™ Fold Down Work Bench is designed to support a 400lb static load evenly distributed over the 24 inch x 60 inch wooden work surface. Placing more than 400lbs on bench top may cause bench to disengage from wall causing personal injury or property damage. **Never place more than 400 lbs on bench top!!**

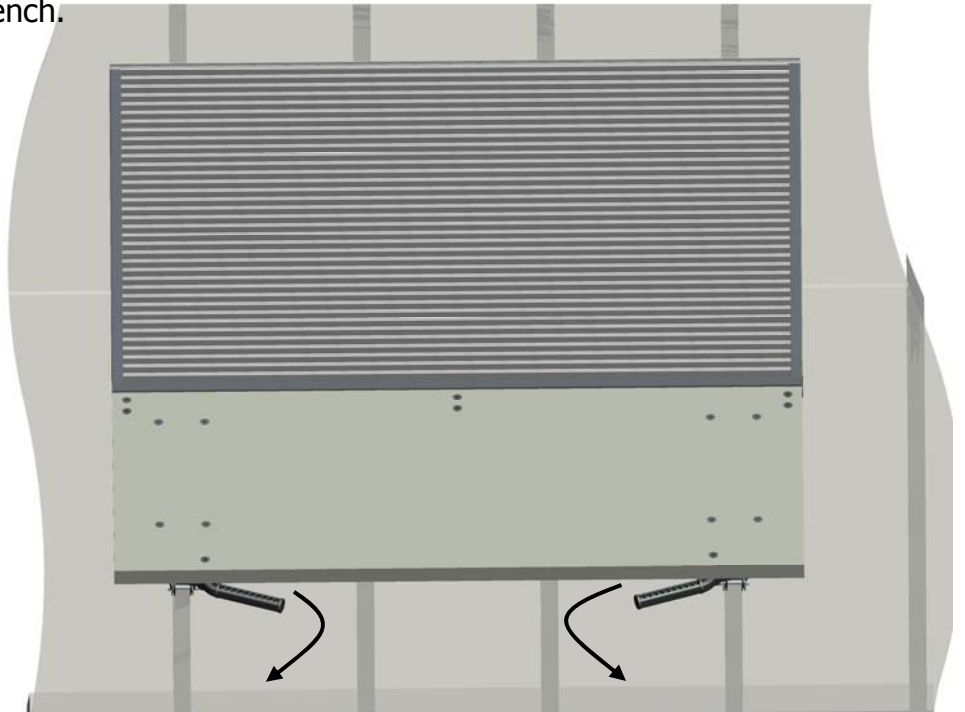

If workbench does not operate properly, you must contact customer service department before attempting to use.
CUSTOMER SERVICE (1-866-223-6247) www.BenchSolution.com

* For alternate mounting methods go to www.BenchSolution.com or call 1-866-223-6247

System Maintenance:

The life of your Bench Solution™ fold down work bench depends on many variables. The climate, exposure to chemicals and **excessive use or misuse** can contribute to the deterioration of the wood surface. While the wood surface is durable and is designed to withstand normal conditions, proper maintenance will extend the life of your bench. As a consumer and Bench Solution owner, you **must** take the following preventive measures:

1. Check bench for loose hardware, excessive wear, and signs of corrosion.
2. Check all Nuts and Bolts once a month. If any are loose, tighten them.
3. Check all parts for excessive wear and tear. If necessary, replace any parts or hardware that have been worn or damaged through usage. Contact our Customer Service Department for **all replacement parts and fasteners.**

Bench Solution™ Fold Down Work Bench Warranty

ONE-YEAR LIMITED WARRANTY

WARRANTY: Bench Solution™ manufactured by Bench Solution Inc. is warranted to be free from defects in material and workmanship for 12 months from the date of the original purchase by the original purchaser, with proof of purchase. In the unlikely event that we deem the product to be defective, Bench Solution Inc. will be responsible for replacement of the defective part ONLY. No cost for labor or installation will be reimbursed. Damages due to shipping and handling, improper installation, abuses (intentional or accidental) or normal wear and tear are NOT covered by this warranty. There are no other guarantees or warranties, implied or expressed beyond the terms of this expressed written warranty.

The proper operation of this product is dependent on the compliance with the Owner's Manual and Assembly Instructions regarding proper installation and operation and maintenance. Failure to comply strictly with those instructions will void the warranty in its entirety.

You must retain your original receipt or order number to be covered by warranty.

To register your warranty, please visit our web-site @ <http://benchsolution.com/WarrantyRegistration.html> or complete enclosed post card.

Contact Information: Customer Service 1-866-223-6247

Web-Site: www.BenchSolution.com

Bench Solution™ Installation Instructions for Concrete Wall Applications

This document details the attachment of the Bench Solution™ to concrete and masonry walls only, for all other assembly instructions refer to the Owner's Manual and Installation Instructions provided with the fold down work bench.

1. Locate and level the Horizontal Wall Bracket as described in Step 1 of the Owner's Manual and Assembly Instructions.
2. Mark the hole locations on the concrete wall.
3. Replace the eight ¼" lag screws, Item number 20, part number BS000067, with eight ¼" x 2- 1/4" Tapcon Hex Head Screws (not provided).
4. Predrill the marked hole locations per the instructions provided with the Tapcon screws.
5. Attach the horizontal wall bracket to the concrete wall using the Tapcon screws and the ¼" flat washers, item number 20, part number BS000110 as shown in Figure 1.
6. Attach the Vertical Wall Brackets as described in Step 2 of the Owner's Manual and Assembly Instructions.
7. Predrill holes for the Vertical Wall Brackets in the concrete wall per instructions provided with the Tapcon screws.
8. Attach the Vertical Wall Brackets to the concrete wall using the Tapcon screws and the ¼" flat washers, item number 20, part number BS000110 as shown in Figure 1.

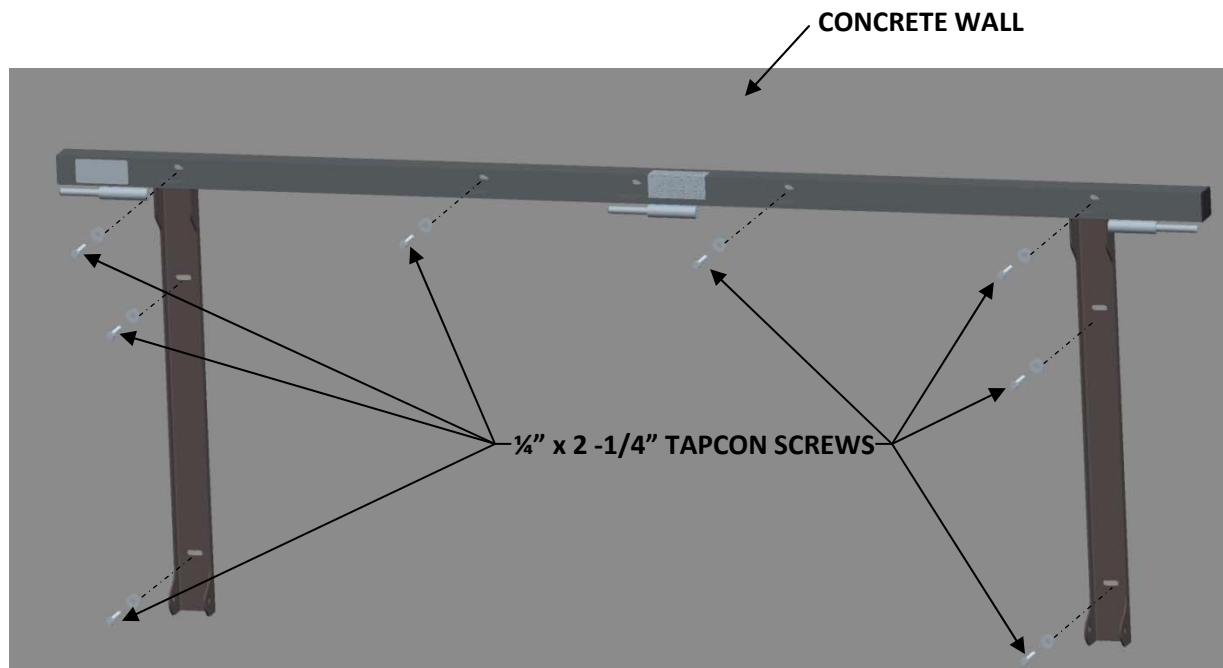

Figure 1



IdealWall™ Installation Instructions for Concrete Wall Applications

Important Information:

To cut IdealWall™ panels use a wood cutting circular saw with a 32 tooth minimum blade. For best results and to avoid panel damage, use IdealWall™ color matched screws part numbers QW75 (white) or QW76 (gray) to attach IdealWall™ panels to furring strips.

Tools Needed:

Pencil, level, tape measure, #2 drive bit, electric drill, and a circular saw.

Installation:

1. Install 1 inch thick furring strips spaced at 16 inches on center on the concrete wall area to be covered with the IdealWall™ panels. Attach furring strips to the concrete wall using flathead Tapcon screws (not provided).
2. Draw a level line on the furring strips at the lowest point you plan to install IdealWall™ panels. See the enlarged view in Figure 1 for proper orientation of IdealWall™ panels. Place the first panel on the level line and place one setting screw at one end. Check level and continue to install screws left to right or right to left.
3. For maximum load capacity use four screws at each furring strip IdealWall™ panel covers. Drive the screws as shown in figure 1 until the head is flush with the panel surface.
4. Place the second panel next to the first panel and install as described in Steps 1 through 3.
5. Continue adding panels until the lowest row of panels is complete.
6. Begin the second row of panels by placing a panel on top of the first row. For best results it is recommended that vertical panel seams are staggered and aligned on furring strips as shown in Figure 1. Ensure joints are fitted correctly to maintain level and spacing. Secure panels in place as described in Step 3.
7. Continue to install panels as described above until desired area is covered.

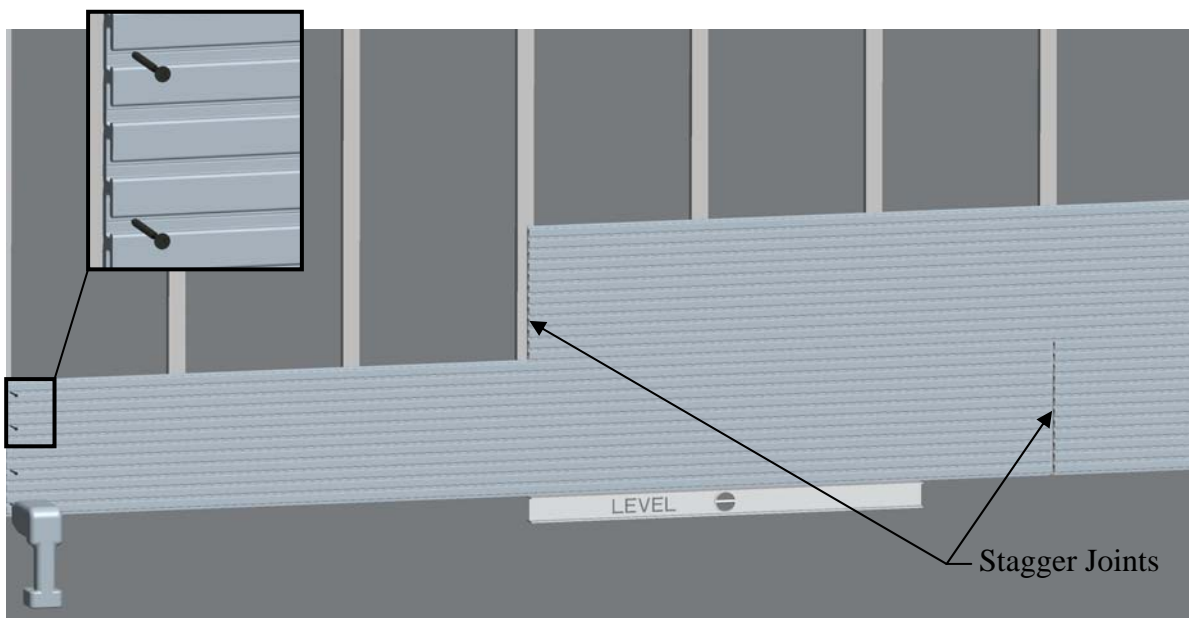

Figure 1 – Concrete Wall with Furring Strips

Installation questions: Contact customer service at 866-223-6247