



# OPERATOR'S MANUAL



## ROTARY DRAW BENDER MODEL: RDB-250

REPRODUCTION OF THIS MANUAL IN ANY FORM WITHOUT WRITTEN APPROVAL OF BAILEIGH INDUSTRIAL, INC. IS PROHIBITED. Baileigh Industrial, Inc. does not assume and hereby disclaims any liability for any damage or loss caused by an omission or error in this Operator's Manual, resulting from accident, negligence, or other occurrence.



## Table of Contents

THANK YOU & WARRANTY .....	1
INTRODUCTION.....	3
GENERAL NOTES.....	3
SAFETY INSTRUCTIONS .....	4
SAFETY PRECAUTIONS .....	7
TECHNICAL SPECIFICATIONS .....	9
TECHNICAL SUPPORT .....	9
UNPACKING AND CHECKING CONTENTS.....	10
Cleaning .....	10
TRANSPORTING AND LIFTING .....	11
INSTALLATION.....	11
ASSEMBLY AND SET UP .....	12
GETTING TO KNOW YOUR MACHINE .....	13
GENERAL DESIGN DESCRIPTION.....	14
ELECTRICAL.....	15
Plug Connection .....	16
OPERATION.....	17
Programmer Overview.....	17
Machine Start up and Homing .....	17
Programmer Display and Key Functions .....	18
Main Menu Choices.....	19
Edit a Program.....	20
Delete Program .....	20
Creating a Program .....	20
Dry Running.....	21
Running a Program .....	21
Manual Bend .....	22
Homing.....	24
OEM Screens and Bending More than 180 Degrees.....	25
OEM Screen Shots.....	26
UNDERSTANDING SPRINGBACK .....	30
MATERIAL SELECTION.....	30
DIE SELECTION AND INSTALLATION.....	31
Material Insertion .....	33
Material Removal / Advancement.....	35
PIPE AND TUBE BENDING DIAGRAMS .....	36
BENDING GLOSSARY .....	37
BENDING SUGGESTIONS .....	38
Aluminum Bending .....	38
Heavy Wall DOM tubing .....	38
Bending With Square Dies .....	39
Square Tooling Setup.....	39



Large Size Square.....	40
INDEX TABLE ATTACHMENT (OPTIONAL EQUIPMENT).....	41
Introduction.....	41
Connection to Your Machine .....	41
Height Adjustment and Leveling .....	41
Material Layout.....	42
Operation .....	42
INDEX TABLE LAYOUT DIAGRAM (OPTIONAL EQUIPMENT) .....	43
LUBRICATION AND MAINTENANCE .....	44
Gear Box Oil.....	44
Main Spindle Bearing .....	44
ELECTRICAL SCHEMATIC.....	45
Electrical Components.....	46
TROUBLESHOOTING .....	47
TABLES, CHARTS, & DIAGRAMS .....	48
Diagram 1 .....	50
Diagram 2 .....	51
PARTS DIAGRAM .....	52
Base Assembly Parts Diagram .....	52
Control Box Parts Diagram.....	53
Drive Assembly Parts Diagram.....	54
Main Bending Assembly Parts Diagram .....	55
Parts List .....	56



**Trick-Tools.com**

80 Truman Road

Pella, IA 50219

Phone:1-877-VAN-SANT

E-mail: sales@trick-tools.com





## THANK YOU & WARRANTY

Thank you for your purchase of a machine from Baileigh Industrial. We hope that you find it productive and useful to you for a long time to come.

**Inspection & Acceptance.** Buyer shall inspect all Goods within ten (10) days after receipt thereof. Buyer's payment shall constitute final acceptance of the Goods and shall act as a waiver of the Buyer's rights to inspect or reject the goods unless otherwise agreed. If Buyer rejects any merchandise, Buyer must first obtain a Returned Goods Authorization ("RGA") number before returning any goods to Seller. Goods returned without a RGA will be refused. Seller will not be responsible for any freight costs, damages to goods, or any other costs or liabilities pertaining to goods returned without a RGA. Seller shall have the right to substitute a conforming tender. Buyer will be responsible for all freight costs to and from Buyer and repackaging costs, if any, if Buyer refuses to accept shipment. If Goods are returned in unsalable condition, Buyer shall be responsible for full value of the Goods. Buyer may not return any special order Goods. Any Goods returned hereunder shall be subject to a restocking fee equal to 30% of the invoice price.

**Specifications.** Seller may, at its option, make changes in the designs, specifications or components of the Goods to improve the safety of such Goods, or if in Seller's judgment, such changes will be beneficial to their operation or use. Buyer may not make any changes in the specifications for the Goods unless Seller approves of such changes in writing, in which event Seller may impose additional charges to implement such changes.

**Limited Warranty.** Seller warrants to the original end-user that the Goods manufactured or provided by Seller under this Agreement shall be free of defects in material or workmanship for a period of twelve (12) months from the date of purchase, provided that the Goods are installed, used, and maintained in accordance with any instruction manual or technical guidelines provided by the Seller or supplied with the Goods, if applicable. The original end-user must give written notice to Seller of any suspected defect in the Goods prior to the expiration of the warranty period. The original end-user must also obtain a RGA from Seller prior to returning any Goods to Seller for warranty service under this paragraph. Seller will not accept any responsibility for Goods returned without a RGA. The original end-user shall be responsible for all costs and expenses associated with returning the Goods to Seller for warranty service. In the event of a defect, Seller, at its sole option, shall repair or replace the defective Goods or refund to the original end-user the purchase price for such defective Goods. Goods are not eligible for replacement or return after a period of 30 days from date of receipt. The foregoing warranty is Seller's sole obligation, and the original end-user's exclusive remedy, with regard to any defective Goods. This limited warranty does not apply to: (a) die sets, tooling, and saw blades; (b) periodic or routine maintenance and setup, (c) repair or replacement of the Goods due to normal wear and tear, (d) defects or damage to the Goods resulting from misuse, abuse, neglect, or accidents, (e) defects or damage to the Goods resulting from improper or unauthorized alterations, modifications, or changes; and (f) any Goods that has not been installed and/or maintained in accordance with the instruction manual or technical guidelines provided by Seller.

**EXCLUSION OF OTHER WARRANTIES.** THE FOREGOING LIMITED WARRANTY IS IN LIEU OF ALL OTHER WARRANTIES, EXPRESS OR IMPLIED. ANY AND ALL OTHER EXPRESS, STATUTORY OR IMPLIED WARRANTIES, INCLUDING BUT NOT LIMITED TO, ANY WARRANTY OF MERCHANTABILITY OR FITNESS FOR ANY PARTICULAR PURPOSE ARE EXPRESSLY DISCLAIMED. NO WARRANTY IS MADE WHICH EXTENDS BEYOND THAT WHICH IS EXPRESSLY CONTAINED HEREIN.

**Limitation of Liability.** IN NO EVENT SHALL SELLER BE LIABLE TO BUYER OR ANY OTHER PARTY FOR ANY INCIDENTAL, CONSEQUENTIAL OR SPECIAL DAMAGES (INCLUDING, WITHOUT LIMITATION, LOST PROFITS OR DOWN TIME) ARISING FROM OR IN MANNER CONNECTED WITH THE GOODS, ANY BREACH BY SELLER OR ITS AGENTS OF THIS AGREEMENT, OR ANY OTHER CAUSE WHATSOEVER, WHETHER BASED ON CONTRACT, TORT OR ANY OTHER THEORY OF LIABILITY. BUYER'S REMEDY WITH RESPECT TO ANY CLAIM ARISING UNDER THIS AGREEMENT IS STRICTLY LIMITED TO NO MORE THAN THE AMOUNT PAID BY THE BUYER FOR THE GOODS.



**Force Majeure.** Seller shall not be responsible for any delay in the delivery of, or failure to deliver, Goods due to causes beyond Seller's reasonable control including, without limitation, acts of God, acts of war or terrorism, enemy actions, hostilities, strikes, labor difficulties, embargoes, non-delivery or late delivery of materials, parts and equipment or transportation delays not caused by the fault of Seller, delays caused by civil authorities, governmental regulations or orders, fire, lightening, natural disasters or any other cause beyond Seller's reasonable control. In the event of any such delay, performance will be postponed by such length of time as may be reasonably necessary to compensate for the delay.

**Installation.** If Buyer purchases any Goods that require installation, Buyer shall, at its expense, make all arrangements and connections necessary to install and operate the Goods. Buyer shall install the Goods in accordance with any Seller instructions and shall indemnify Seller against any and all damages, demands, suits, causes of action, claims and expenses (including actual attorneys' fees and costs) arising directly or indirectly out of Buyer's failure to properly install the Goods.

**Work By Others; Safety Devices.** Unless agreed to in writing by Seller, Seller has no responsibility for labor or work performed by Buyer or others, of any nature, relating to design, manufacture, fabrication, use, installation or provision of Goods. Buyer is solely responsible for furnishing, and requiring its employees and customers to use all safety devices, guards and safe operating procedures required by law and/or as set forth in manuals and instruction sheets furnished by Seller. Buyer is responsible for consulting all operator's manuals, ANSI or comparable safety standards, OSHA regulations and other sources of safety standards and regulations applicable to the use and operation of the Goods.

**Remedies.** Each of the rights and remedies of Seller under this Agreement is cumulative and in addition to any other or further remedies provided under this Agreement or at law or equity.

**Attorney's Fees.** In the event legal action is necessary to recover monies due from Buyer or to enforce any provision of this Agreement, Buyer shall be liable to Seller for all costs and expenses associated therewith, including Seller's actual attorneys' fees and costs.

**Governing Law/Venue.** This Agreement shall be construed and governed under the laws of the State of Wisconsin, without application of conflict of law principles. Each party agrees that all actions or proceedings arising out of or in connection with this Agreement shall be commenced, tried, and litigated only in the state courts sitting in Manitowoc County, Wisconsin or the U.S. Federal Court for the Eastern District of Wisconsin. Each party waives any right it may have to assert the doctrine of "forum non conveniens" or to object to venue to the extent that any proceeding is brought in accordance with this section. Each party consents to and waives any objection to the exercise of personal jurisdiction over it by courts described in this section. Each party waives to the fullest extent permitted by applicable law the right to a trial by jury.

**Summary of Return Policy.**

- 10 Day acceptance period from date of delivery. Damage claims and order discrepancies will not be accepted after this time.
- You must obtain a Baileigh issued RGA number PRIOR to returning any materials.
- Returned materials must be received at Baileigh in new condition and in original packaging.
- Altered items are not eligible for return.
- Buyer is responsible for all shipping charges.
- A 30% re-stocking fee applies to all returns.

Baileigh Industrial makes every effort to ensure that our posted specifications, images, pricing and product availability are as correct and timely as possible. We apologize for any discrepancies that may occur. Baileigh Industrial reserves the right to make any and all changes deemed necessary in the course of business including but not limited to pricing, product specifications, quantities, and product availability.

**For Customer Service & Technical Support:**

Please contact one of our knowledgeable Sales and Service team members at: (920) 684-4990 or e-mail us at [sales@baileighindustrial.com](mailto:sales@baileighindustrial.com)



## **INTRODUCTION**

*The quality and reliability of the components assembled on a Baileigh Industrial machine guarantee near perfect functioning, free from problems, even under the most demanding working conditions. However if a situation arises, refer to the manual first. If a solution cannot be found, contact the distributor where you purchased our product. Make sure you have the serial number and production year of the machine (stamped on the nameplate). For replacement parts refer to the assembly numbers on the parts list drawings.*

*Our technical staff will do their best to help you get your machine back in working order.*

### **In this manual you will find: (when applicable)**

- Safety procedures
- Correct installation guidelines
- Description of the functional parts of the machine
- Capacity charts
- Set-up and start-up instructions
- Machine operation
- Scheduled maintenance
- Parts lists

## **GENERAL NOTES**

After receiving your equipment remove the protective container. Do a complete visual inspection, and if damage is noted, **photograph it for insurance claims** and contact your carrier at once, requesting inspection. Also contact Baileigh Industrial and inform them of the unexpected occurrence. Temporarily suspend installation.

Take necessary precautions while loading / unloading or moving the machine to avoid any injuries.

Your machine is designed and manufactured to work smoothly and efficiently. Following proper maintenance instructions will help ensure this. Try and use original spare parts, whenever possible, and most importantly; **DO NOT** overload the machine or make any unauthorized modifications.



**Note:** This symbol refers to useful information throughout the manual.



## **IMPORTANT** **PLEASE READ THIS OPERATORS MANUAL CAREFULLY**

It contains important safety information, instructions, and necessary operating procedures. The continual observance of these procedures will help increase your production and extend the life of the equipment.

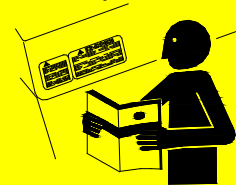

## **SAFETY INSTRUCTIONS**

### **LEARN TO RECOGNIZE SAFETY INFORMATION**

This is the safety alert symbol. When you see this symbol on your machine or in this manual, **BE ALERT TO THE POTENTIAL FOR PERSONAL INJURY!**

Follow recommended precautions and safe operating practices.

### **UNDERSTAND SIGNAL WORDS**

A signal word – **DANGER**, **WARNING**, or **CAUTION** is used with the safety alert symbol. **DANGER** identifies a hazard or unsafe practice that will result in severe **Injury or Death**.

Safety signs with signal word **DANGER** or **WARNING** are typically near specific hazards.

General precautions are listed on **CAUTION** safety signs. **CAUTION** also calls attention to safety messages in this manual.



**DANGER**



**WARNING**



**CAUTION**



**SAVE THESE INSTRUCTIONS.**  
**Refer to them often and use them to instruct others.**



**PROTECT EYES**

Wear safety glasses or suitable eye protection when working on or around machinery.

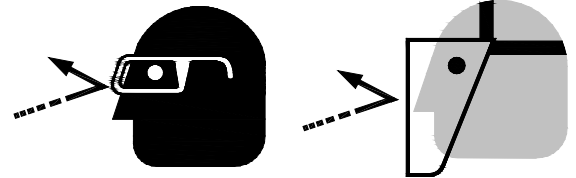

**PROTECT AGAINST NOISE**

Prolonged exposure to loud noise can cause impairment or loss of hearing. Wear suitable hearing protective devices such as ear muffs or earplugs to protect against objectionable or uncomfortable loud noises.

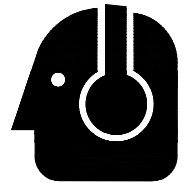

**BEWARE OF CRUSH HAZARD**

**NEVER** place your hands, fingers, or any part of your body in the die area of this machine. Be aware of the area on either side of the dies for crush points created by material movement.

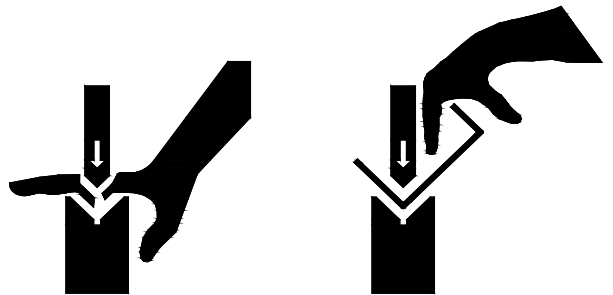

**BEWARE OF PINCH POINTS**

Keep hands and fingers away from the drive mechanisms, cylinders, ratchets, and other moving linkage while the machine is in operation.

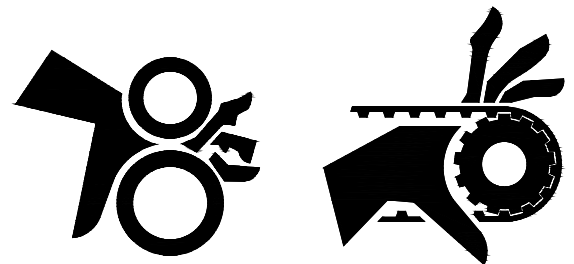





### KEEP CLEAR OF MOVING OBJECTS

Always be aware of the position of the material and the swing area in which the material will travel. The material will swing with significant force. This swing area will create pinch points and the force of the material movement may cause serious bodily injuries.

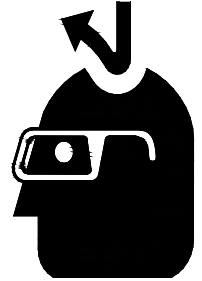

### HYDRAULIC HOSE FAILURE

Exercise **CAUTION** around hydraulic hoses in case of a hose or fitting failure.

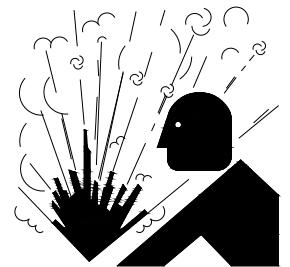

### HIGH VOLTAGE

**USE CAUTION IN HIGH VOLTAGE AREAS. DO NOT** assume the power to be off.  
**FOLLOW PROPER LOCKOUT PROCEDURES.**

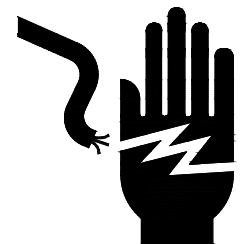



## SAFETY PRECAUTIONS



Metal working can be dangerous if safe and proper operating procedures are not followed. As with all machinery, there are certain hazards involved with the operation of the product. Using the machine with respect and caution will considerably lessen the possibility of personal injury. However, if normal safety precautions are overlooked or ignored, personal injury to the operator may result.

Safety equipment such as guards, hold-downs, safety glasses, dust masks and hearing protection can reduce your potential for injury. But even the best guard won't make up for poor judgment, carelessness or inattention. **Always use common sense** and exercise **caution** in the workshop. If a procedure feels dangerous, don't try it.

**REMEMBER: Your personal safety is your responsibility.**



**WARNING: FAILURE TO FOLLOW THESE RULES MAY RESULT IN SERIOUS PERSONAL INJURY**

1. **Only trained and qualified personnel can operate this machine.**
2. **Make sure guards are in place and in proper working order before operating machinery.**
3. **Remove any adjusting tools.** Before operating the machine, make sure any adjusting tools have been removed.
4. **Keep work area clean.** Cluttered areas invite injuries.
5. **Overloading machine.** By overloading the machine you may cause injury from flying parts. **DO NOT** exceed the specified machine capacities.
6. **Dressing material edges.** Always chamfer and deburr all sharp edges.
7. **Do not force tool.** Your machine will do a better and safer job if used as intended. **DO NOT** use inappropriate attachments in an attempt to exceed the machines rated capacity.
8. **Use the right tool for the job. DO NOT** attempt to force a small tool or attachment to do the work of a large industrial tool. **DO NOT** use a tool for a purpose for which it was not intended.
9. **Dress appropriate. DO NOT** wear loose fitting clothing or jewelry as they can be caught in moving machine parts. Protective clothing and steel toe shoes are recommended when using machinery. Wear a restrictive hair covering to contain long hair.
10. **Use eye and ear protection.** Always wear ISO approved impact safety goggles. Wear a full-face shield if you are producing metal filings.



11. **Do not overreach.** Maintain proper footing and balance at all times. **DO NOT** reach over or across a running machine.
12. **Stay alert.** Watch what you are doing and use common sense. **DO NOT** operate any tool or machine when you are tired.
13. **Check for damaged parts.** Before using any tool or machine, carefully check any part that appears damaged. Check for alignment and binding of moving parts that may affect proper machine operation.
14. **Observe work area conditions.** **DO NOT** use machines or power tools in damp or wet locations. Do not expose to rain. Keep work area well lighted. **DO NOT** use electrically powered tools in the presence of flammable gases or liquids.
15. **Keep children away.** Children must never be allowed in the work area. **DO NOT** let them handle machines, tools, or extension cords.
16. **Store idle equipment.** When not in use, tools must be stored in a dry location to inhibit rust. Always lock up tools and keep them out of reach of children.
17. **DO NOT operate machine if under the influence of alcohol or drugs.** Read warning labels on prescriptions. If there is any doubt, **DO NOT** operate the machine.
18. **DO NOT** touch live electrical components or parts.
19. **Turn off** power before checking, cleaning, or replacing any parts.
20. Be sure **all** equipment is properly installed and grounded according to national, state, and local codes.
21. **DO NOT** bypass or defeat any safety interlock systems.
22. Keep visitors a safe distance from the work area.



## TECHNICAL SPECIFICATIONS

Maximum Center Line Radius (CLR)*	9" (229mm)
Minimum Center Line Radius (CLR)*	.5" (12.7mm)
Minimum OD	.25" (6.35mm)
Mild Steel Pipe (Schedule 40) Based on a material tensile strength of 60000 PSI – mild steel	2" (50.8mm)
Aluminum Pipe (Schedule 40)	2" (50.8mm)
Stainless Steel Pipe (Schedule 40)	1.5" (38.1mm)
Mild Steel Round Tube (Wall)	2.5" (.125) (63.5mm [3.175mm])
Aluminum Round Tube (Wall)	2.5" (.156) (63.5mm [3.96mm])
Stainless Steel Round Tube (Wall)	2.375" (.125) (60.325mm [3.175mm])
Chromolly Round Tube (Wall)	2" (.125) (50.8mm [3.175mm])
Mild Steel Solid Rod	1.25" (31.75mm)
Mild Steel Square Tube (Wall)	2" (.125) (50.8mm [3.175mm])
Maximum Speed to 180	9 Seconds
Power Supply	208-240 VAC, 20A, 1ph, 60Hz (250-460 VAC, 10A, 3ph, 50/60Hz) available
Sound level	<70db
Shipping Weight (Lbs.)	610lbs. (277kg)
Shipping Dimensions (L x W x H)	68 x 60" x 44" (1727 x 1524 x 1118mm)

\*CLR will vary based upon actual material and wall thickness.

## TECHNICAL SUPPORT

Our technical support department can be reached at 920.684.4990, and asking for the support desk for purchased machines. Tech Support handles questions on machine setup, schematics, warranty issues, and individual parts needs: (other than die sets and blades).

For specific application needs or future machine purchases contact the Sales Department at: [sales@baileighindustrial.com](mailto:sales@baileighindustrial.com), Phone: 920.684.4990, or Fax: 920.684.3944.



**Note:** The photos illustrations used in this manual are representative only and may not depict the actual color, labeling or accessories and may be intended to illustrate technique only.



**Note:** The specifications and dimensions presented here are subject to change without prior notice due to improvements of our products.



## UNPACKING AND CHECKING CONTENTS

Your Baileigh machine is shipped complete in one crate. Separate all parts from the packing material and check each item carefully. Make certain all items are accounted for before discarding any packing material.

**⚠ WARNING: SUFFOCATION HAZARD!** Immediately discard any plastic bags and packing materials to eliminate choking and suffocation hazards to children and animals.

If any parts are missing, do not plug in the power cable, or turn the power switch on until the missing parts are obtained and installed correctly.

### Cleaning

Your machine may be shipped with a rustproof waxy oil coating and grease on the exposed unpainted metal surfaces. To remove this protective coating, use a degreaser or solvent cleaner. For a more thorough cleaning, some parts will occasionally have to be removed. **DO NOT USE** acetone or brake cleaner as they may damage painted surfaces.

Follow manufacturer's label instructions when using any type of cleaning product. After cleaning, wipe unpainted metal surfaces with a light coating of quality oil or grease for protection.

**⚠ WARNING: DO NOT USE** gasoline or other petroleum products to clean the machine. They have low flash points and can explode or cause fire.

**⚠ CAUTION:** When using cleaning solvents work in a well-ventilated area. Many cleaning solvents are toxic if inhaled.





## **TRANSPORTING AND LIFTING**

**⚠ CAUTION:** Lifting and carrying operations should be carried out by skilled workers, such as a truck operator. Make sure the machine is well balanced. Choose a location that will keep the machine free from vibration and dust from other machinery. Keep in mind that having a large clearance area around the machine is important for safe and efficient working conditions.

### **Follow these guidelines when lifting:**

- The lift truck must be able to lift at least 1.5 – 2 times the machines gross weight.
- Make sure the machine is balanced. While transporting, avoid rough or jerky motion, and maintain a safe clearance zone around the transport area.
- Use a fork lift with sufficient lifting capacity and forks that are long enough to reach the complete width of the machine.
- Remove the securing bolts that attach the machine to the pallet.
- Approaching the machine from the side, lift the machine on the frame taking care that there are no cables or pipes in the area of the forks.
- Move the machine to the required position and lower gently to the floor.
- Level the machine so that all the supporting feet are taking the weight of the machine and no rocking is taking place.

## **INSTALLATION**

### **IMPORTANT:**

Consider the following when looking for a suitable location to place the machine:

- Overall weight of the machine.
- Weight of material being processed.
- Sizes of material to be processed through the machine.
- Space needed for auxiliary stands, work tables, or other machinery.
- Clearance from walls and other obstacles.
- Maintain an adequate working area around the machine for safety.
- Have the work area well illuminated with proper lighting.



- Keep the floor free of oil and make sure it is not slippery.
- Remove scrap and waste materials regularly, and make sure the work area is free from obstructing objects.
- If long lengths of material are to be fed into the machine, make sure that they will not extend into any aisles.
- **LEVELING:** The machine should be sited on a level, concrete floor. For stationary machines, provisions for securing it should be in position prior to placing the machine. The accuracy of any machine depends on the precise placement of it to the mounting surface.
- **FLOOR:** This tool distributes a large amount of weight over a small area. Make certain that the floor is capable of supporting the weight of the machine, work stock, and the operator. The floor should also be a level surface. If the unit wobbles or rocks once in place, be sure to eliminate by using shims.
- **WORKING CLEARANCES:** Take into consideration the size of the material to be processed. Make sure that you allow enough space for you to operate the machine freely.
- **POWER SUPPLY PLACEMENT:** The power supply should be located close enough to the machine so that the power cord is not in an area where it would cause a tripping hazard. Be sure to observe all electrical codes if installing new circuits and/or outlets.

## **ASSEMBLY AND SET UP**

 **WARNING:** For your own safety, **DO NOT** connect the machine to the power source until the machine is completely assembled and you read and understand the entire instruction manual.

1. Remove the machine from the skid it was shipped on and install the casters.
2. Check the oil level and top off if necessary.
3. Read through the remainder of the manual and become familiar with the die installation and settings as well as normal operation.
4. Position the machine as desired following the installation guidelines.
5. Follow the electrical guidelines to connect the machine to a power supply.



GETTING TO KNOW YOUR MACHINE







Item	Description	Function
A	Grease Zerk	For Greasing Main Spindle Bearing
B	Main Spindle And Drive Pins	For Supporting The Bend Dies And Driving The Dies
C	Center Pin	For Aligning Die Onto Spindle
D	Hitch Pin	For Mounting The Counter Die
E	Quick Release	For Pivoting Counter Die Away From Bend Die To Remove Material Quickly
F	Numerical Counter	For Indicating Counter Die Position
G	Touch Screen Controller	For Programming Bend Data
H	3 Legged Handwheel	For Adjusting Counter Die Position
I	Main Disconnect Switch	For Turning Power On/Off
J	Push Handle	For Maneuvering Machine On Its Wheels
K	Power Cord	For Connecting To Main Power Source
L	Foot Pedal Guard	Protect Against Accidental Operation
M	Forward Foot Pedal	Will Operate The Machine In The cw Direction
N	Reverse Foot Pedal	Will Operate The Machine In The ccw Direction

## **GENERAL DESIGN DESCRIPTION**

You have made a practical choice in purchasing the RDB-250 Fully Programmable Bending Machine. It has been carefully built of high quality materials and designed to give many years of efficient service. The simplicity of design and minimum effort required to operate the machine contributes towards meeting schedules and producing greater profits.

The RDB-250 is an electric powered "Rotary Draw" bending machine. To bend material, a bending die and counter die are required. The material is hooked by the bending dies' hook arm and is powerfully rotated in the clockwise direction. As the bending die rotates, the counter die remains stationary, forcing the material to conform to the radius and shape of the bending die. The RDB-250 Bending Machine you have purchased is built of solid steel ensuring maximum rigidity. Tongue and groove design with grade 8 bolts throughout provides very high rigidity and stability.

Throughout this manual are listed various safety-related descriptions for attention. These matters for attention contain the essential information to the operators while operating, and maintaining. Failure to follow these instructions may result in great damage to the machine or injury to the operator.



## ELECTRICAL

 **CAUTION:** HAVE ELECTRICAL UTILITIES CONNECTED TO MACHINE BY A CERTIFIED ELECTRICIAN!  
Check if the available power supply is the same as listed on the machine nameplate.

 **WARNING:** Make sure the grounding wire (green) is properly connected to avoid electric shock. DO NOT switch the position of the green grounding wire if any electrical plug wires are switched during hookup.

### Motor Specifications

Your tool is wired for 220 volt, 60Hz alternating current. Before connecting the tool to the power source, make sure the machine is cut off from power source.

### Considerations

- Observe local electrical codes when connecting the machine.
- The circuit should be protected with a time delay fuse or circuit breaker with a amperage rating slightly higher than the full load current of machine.
- A separate electrical circuit should be used for your tools. Before connecting the motor to the power line, make sure the switch is in the "OFF" position and be sure that the electric current is of the same characteristics as indicated on the tool.
- All line connections should make good contact. Running on low voltage will damage the motor.
- In the event of a malfunction or breakdown, grounding provides a path of least resistance for electric current to reduce the risk of electric shock. This tool is equipped with an electric cord having an equipment-grounding conductor and a grounding plug. The plug must be plugged into a matching outlet that is properly installed and grounded in accordance with all local codes and ordinances.

 **WARNING:** In all cases, make certain the receptacle in question is properly grounded. If you are not sure, have a qualified electrician check the receptacle.



- Improper connection of the equipment-grounding conductor can result in risk of electric shock. The conductor with insulation having an outer surface that is green with or without yellow stripes is the equipment-grounding conductor. If repair or replacement of the electric cord or plug is necessary, do not connect the equipment-grounding conductor to a live terminal.
- Check with a qualified electrician or service personnel if the grounding instructions are not completely understood, or if in doubt as to whether the tool is properly grounded.
- Repair or replace damaged or worn cord immediately.

### **Extension Cord Safety**

Extension cord should be in good condition and meet the minimum wire gauge requirements listed below:

AMP RATING	LENGTH		
	25ft	50ft	100ft
0-6	16	16	16
7-10	16	16	14
11-12	16	16	14
13-16	14	12	12
17-20	12	12	10
21-30	10	10	No
WIRE GAUGE			

An undersized cord decreases line voltage, causing loss of power and overheating. All cords should use a ground wire and plug pin. Replace any damaged cords immediately.

### **Plug Connection**

1. Have an electrician install the correct plug for the application.
2. Once hooked up, turn on the power supply and start the machine.
3. For three phase applications, check that the motor is running in the correct direction.
4. If not, cut the power to the machine. Swap the position of any two of the three power wires; but **DO NOT** change the position of the green grounding wire!

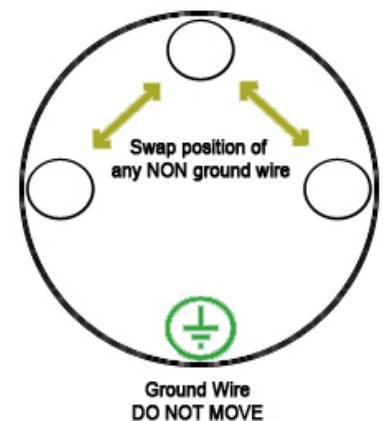



## OPERATION

**⚠ CAUTION:** Always wear proper eye protection with side shields, safety footwear, and leather gloves to protect from burrs and sharp edges.

**⚠ CAUTION:** Keep hands and fingers clear of the dies and swing arms. Stand to the front of the machine to avoid getting hit with the material during the bending process. When handling large heavy materials make sure they are properly supported.

### Programmer Overview

- This draw bender utilizes a fully programmable touch screen operator interface. The unique operator interface allows you to write and save 170 programs with 10 bends per program. Operation is extremely simple to learn. Simple foot pedal controls allow you to easily produce fast and accurate bends. The following instructions will walk you through the basic functions.
- Be sure to follow the dry running instructions to familiarize yourself with all the functions of the control before any actual bending of material is performed.



**Note:** See the Screen Shots section of the manual to match the figure call outs.

### Machine Start up and Homing

1. Turn the main power switch to the "ON" position.
2. It takes about 1 minute for the programmer to boot up. The machine has been homed from the factory and does not need to be re-homed unless the encoder or drive motor needs servicing. In the Home or "0" position, the flat of the spindle is parallel to the machine frame.
3. The programmer will display the "RMD MAIN SCREEN" see Fig.1.
4. On the RMD MAIN SCREEN, you can choose "MANUAL MODE" or "RUN, VIEW OR EDIT A PROGRAM".



OP Screen Figure 1



## Programmer Display and Key Functions

1. The touch screen control is very self-explanatory. By touching the labeled touch boxes on the screen, the listed parameter or function will be selected. The exit box will return you to the previous screen and get you back to the RMD MAIN SCREEN. When entering names and degrees, a keypad will be displayed Fig 2, 3, and 4 to allow switching between alpha and numeric keys.



OP Screen Figure 2



OP Screen Figure 3

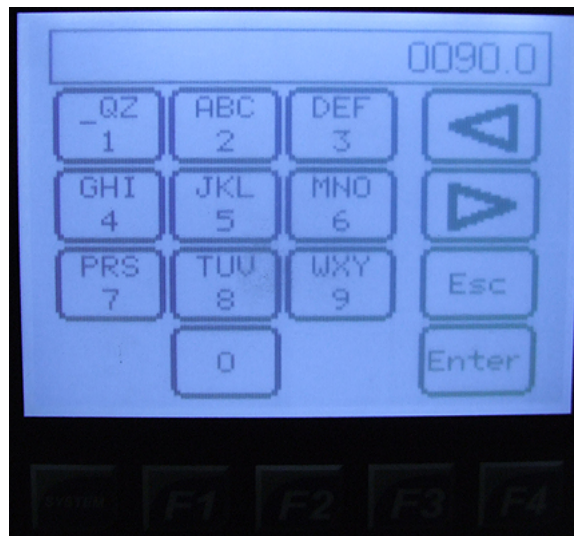

OP Screen Figure 4



## Main Menu Choices

1. "RUN, VIEW OR EDIT A PROGRAM" Select this Feature if you want to:

Run a program

View the settings of an existing program

Edit or create a program.

- Up to 170 programs with 10 bends per program can be created using any alphanumeric characters.
- From the Program selector screen Fig 5, choose the program you wish to edit by touching the name of the program from the right side column. Use the up and down arrows to move the screen up or down one line or one page at a time. Dashed lines in the name indicate that no program is saved to that location.

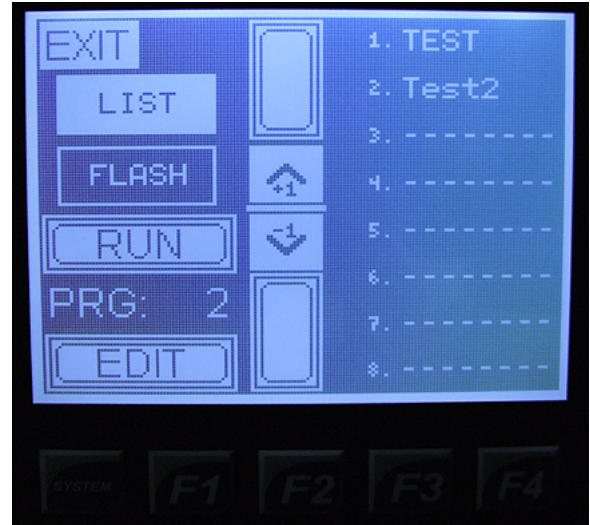

OP Screen Figure 5

- After selecting the program. Touch the EDIT button (Fig 5) and the program parameters will be displayed Fig 6. Press the View button at the top of the screen to change to the Edit mode.
- Verify that the bend to be edited is selected. Press the box for the parameter to be changed and the digit key pad will open. Enter the desired numbers. Add zeros as needed to move the decimal position.
- When the changes have been completed, press the SYSTEM button below the Save box. If this is a new program, the alpha key pad will open to allow the program to be named and saved.

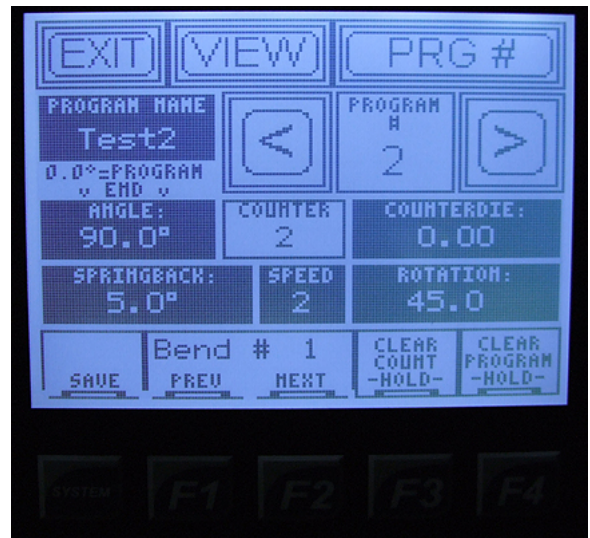

OP Screen Figure 6



**Note:** The bottom row of function boxes are controlled by the actual buttons below the touch screen.



## Edit a Program

1. Select this feature when you want to edit an existing program.
  - a. From the Program selector screen Fig 5, choose the program number to be edited.  
Use the up and down arrows to move the screen up or down one line or one page at a time. Dashed lines in the name indicate that no program is saved to that location.
  - b. After selecting the program line. Touch the EDIT button (Fig 5) and the program parameters will be displayed Fig 6. Press the View button at the top of the screen to change to the Edit mode.
  - c. Verify that the bend to be edited is selected. Press the box for the parameter to be changed and the digit key pad will open. Enter the desired numbers. Add zeros as needed to move the decimal position.
  - d. When the changes have been completed, press the System button (Fig. 6) below the Save box. If this is a new program, the alpha key pad (Fig. 2 and 3) will open to allow the program to be named and saved.
2. After selecting the program touch the RUN button (Fig 5) and the program parameters will be displayed Fig 7.
3. At this point, the display reads "Press FWD Pedal to Bend". Pressing the forward foot pedal will start the bending process. The machine will rotate in the selected direction at the chosen speed to the desired degree totaling the bend angle plus the spring back degrees.
4. When at the final position, the control will prompt you to "Press REV Pedal to Home".

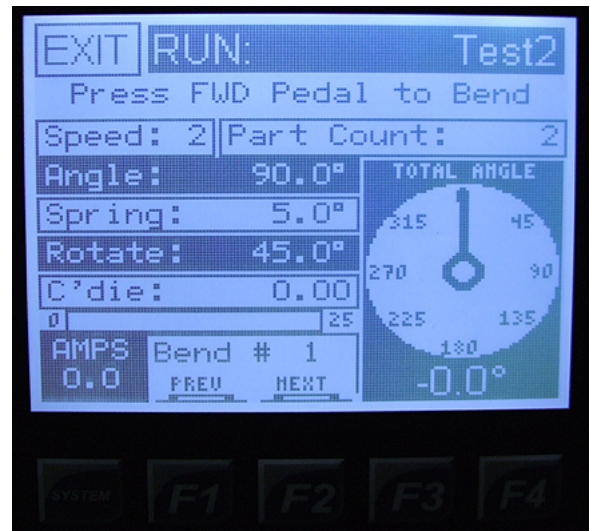

OP Screen Figure 7

## Delete Program

1. Follow the above steps to get to the edit screen Fig 6. Press and hold the F3 button below the CLEAR PROGRAM box to erase all of the bend data for the selected program.

## Creating a Program

1. Choose "RUN, VIEW OR EDIT A PROGRAM" from the RMD MAIN SCREEN Fig 1.
2. Select an open program number from 1 to 170 Fig 5. If all of the program numbers have been filled, then an existing file will need to be overwritten to the new program parameters.
3. When the desired program slot has been selected, press, EDIT Fig 5.



4. After selecting the program line. Touch the EDIT button and the program parameters will be displayed Fig 6. Press the View button in the upper right corner to change to the Edit mode.
5. On the edit screen enter the desired PROGRAM NAME by touching the name field Fig. 6.
6. The alpha key pad (Fig. 2 and 3) will open. Name the file for future reference, (There is an 8 character limit) and press enter to save the name and return to the previous screen.
7. Enter the bend ANGLE Fig 6.
8. Enter the SPRING BACK Fig 6.
9. Enter the SPEED from 1-6. Fig 6, 1 or 2 recommended. The closer to bend capacity, the slower the speed setting should be.
10. Enter a COUNTERDIE POSITION (Fig 8, just a reference number taken from the leadscrew counter).
11. Enter a MATERIAL ROTATION if desired. (Normally the first bend is at zero.)
12. Repeat above steps for Bends #2 to #10.
13. Press the SYSTEM button below the Save box to save the program.
14. From the Program selector screen (Fig 5) press Run to run the program.



OP Screen Figure 8

### Dry Running

- Once you are familiar with the machine and programming unit, it is important to dry run a few programs without any tooling or material installed.
- Follow the steps in the Running a Program sections to dry run the program.
- Repeat this process as many times as needed to fully understand the functions and controls.

**⚠ CAUTION:** Do not attempt to operate if you are not confident or do not understand the controls! Feel free to consult the factory with any questions.

### Running a Program

1. Choose "RUN, VIEW OR EDIT A PROGRAM" from the RMD MAIN SCREEN Fig 1.
2. To edit a program, choose the program you wish to edit by touching the name of the program from the right side column. Use the up and down arrows to move the screen up or





down one line or one page at a time. Dashed lines in the name indicate that no program is saved to that location.

3. After selecting the program touch the RUN button and the program parameters will be displayed Fig 7.
4. Verify the spindle is clear and ready to perform a dry run or that the die is secure and material properly loaded.
5. Press and hold the Forward foot pedal down to produce the sample bend.
6. When at the final position, the screen will read, "Bend Done. Release FWD Pedal" and then "Press REV Pedal to Home".
7. Press and hold the reverse foot pedal until the spindle reaches "0" degrees.
8. If a second or more bends have been programmed, the Bend # display will change to the next bend number. This will be the next bend and so on all the way to the last programmed bend up to bend 10.
9. Reposition or load the material for the next bend.
10. If only 1 bend is programmed, bend 1 will be repeated until the program is exited and a different program is loaded.

### **Manual Bend**

Manual Operation has two control levels. Manual Mode and Full Manual Mode.

### **Manual Mode**

Manual Mode allows for bending to specific angles with or without springback allowance. Select this feature to bend manually without the need to create a program but still be able to stop at a specific angle. The angle indicator will display the relative bend angle with the actual degree shown below the dial.

1. On the RMD MAIN SCREEN, chose "MANUAL MODE" Fig 1.
2. Press on the Angle box to open the key pad (Fig. 4) and then enter the angle.
3. If a spring back is required, press on the Spring box to open the key pad (Fig. 4) and then enter the amount of spring back angle.
4. With the arrow keys a bend speed from 1-6 can be selected, 1 or 2 recommended. The closer to bend capacity, the slower the speed setting should be.

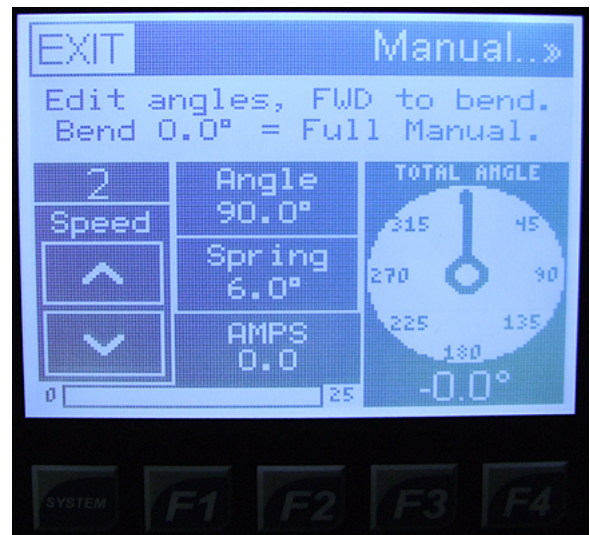

OP Screen Figure 8



5. When the angle and speed settings have been entered, the bend may be dry run or an actual bend may be performed.

### **Full Manual Mode**

Full Manual Mode allows for bending to any angle between 0.0 and 200.0 degrees with only the operator controlling the stop point.

The speed is controlled with the arrow keys from speed 1-6, 1 or 2 recommended. The closer to bend capacity, the slower the speed setting should be.

This operation should also be considered to be run at a slower speed as there is no stop point programmed in. This means that the operator will need to release the foot pedal at the bend angle desired.

The actual degree will be displayed while in this mode.



OP Screen Figure 9



## Homing



**IMPORTANT:** Don't Change the home position unless you are sure the position was lost, damage to the machine and tooling can occur if the home position is set incorrectly.

1. The machine has been homed from the factory and does not need to be re-homed unless the encoder or drive motor needs servicing. In the Home or "0" position, the flat of the spindle is parallel to the machine frame. Verify that the spindle is at the home position using the manual function before moving to the next step.

- a. Measure from each end of the flat on the spindle to the edge of the bending frame. The two dimensions must be exactly the same in the Home position. Slow the Motor Speed to the slowest position if having difficulties tapping the foot pedals to get the exact setting.

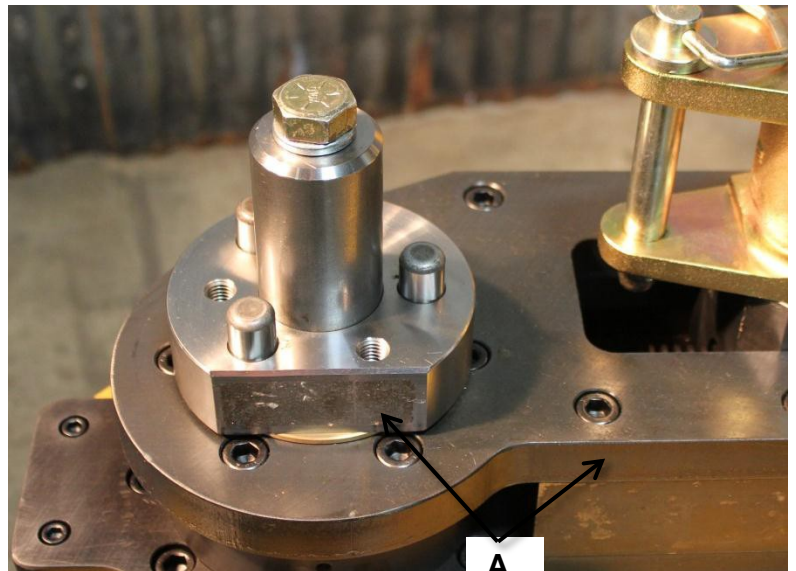

2. To set the home position, press the upper right corner of the screen (Fig 1) to display OEM Screen Fig. 11.
3. Press the Options button (Fig. 11) to enter the Options screen Fig 12.

4. Press the Set Home button (Fig. 12) to enter the Home screen Fig 13.

5. Once in the Machine Homing screen, follow the directions on the screen to set the home position.

The Home position is saved even if the power is shut down for a short time such as overnight. You may lose the home position if power is lost to the machine during a move or if wiring or electronics are disconnected inside the electrical cabinet.

6. Press the Exit button to keep the existing Home position. Press and hold the save button at the bottom of the screen to save the new Home position.

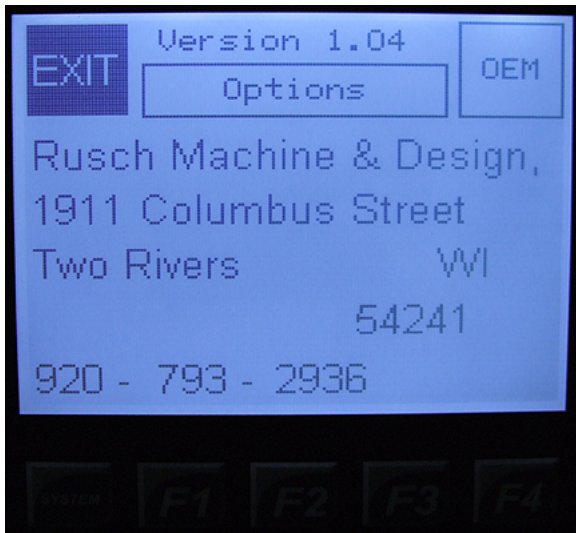

OEM Screen Figure 11

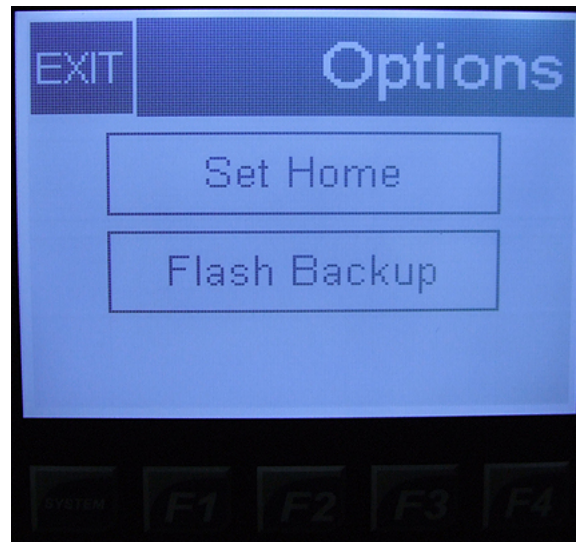

OEM Screen Figure 12

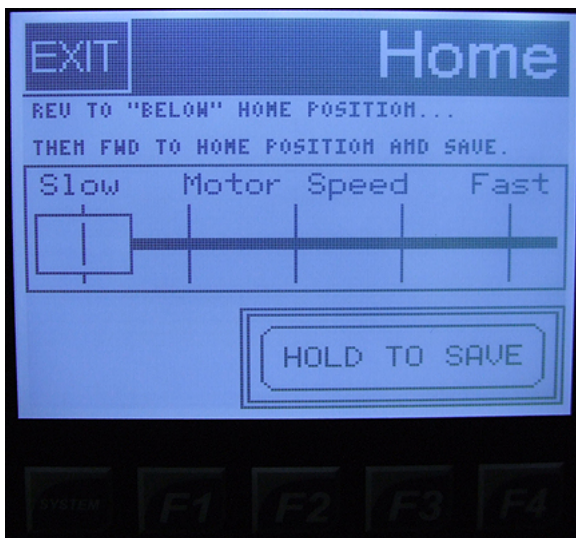

OEM Screen Figure 13

### **OEM Screens and Bending More than 180 Degrees**

- Parameters in the OEM MENU should only be done after consulting the factory. Changing these parameters without consulting the factory will void the warranty.
- This machine is capable of bending more than 180 degrees. Contact Baileigh Industrial about your application.
  - It will require a password to make the machine go past 200 degrees.
  - Requires special tooling to allow removal of bent part. If standard tooling is used, the material will be locked onto the die.



- Activation of bi directional option should only be done at the factory. Consult the factory for specific information.

### OEM Screen Shots



OP Screen Figure 1

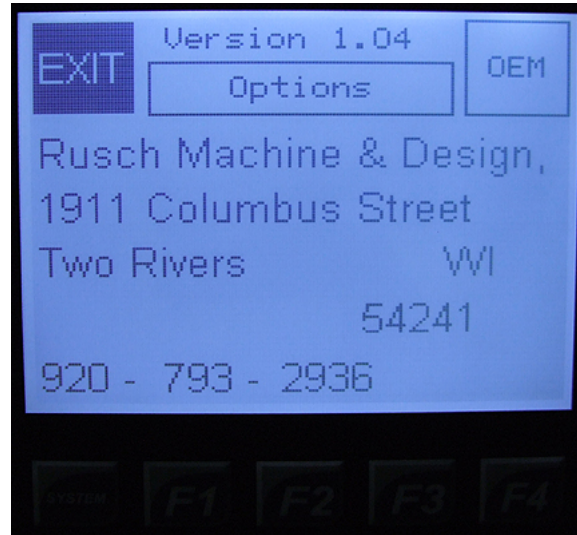

OEM Screen Figure 11

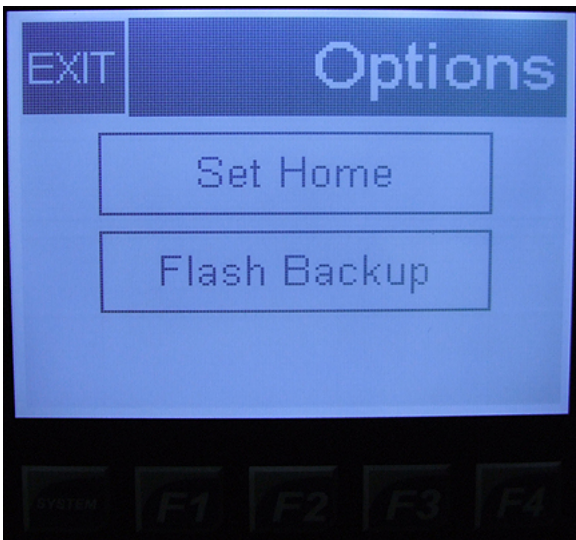

OEM Screen Figure 12

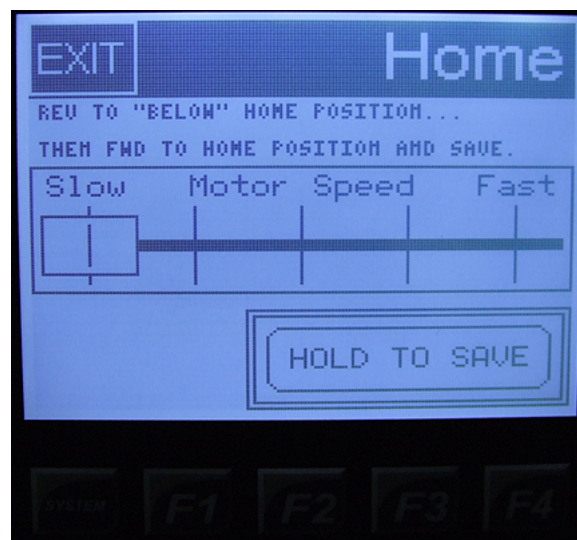

OEM Screen Figure 13

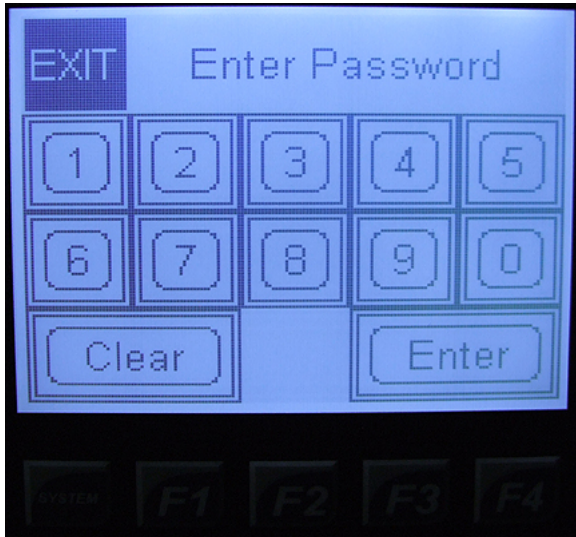

OEM Screen Figure 14

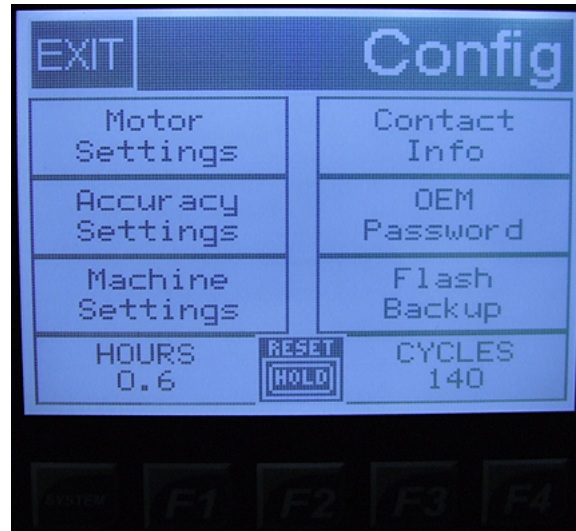

OEM Screen Figure 15

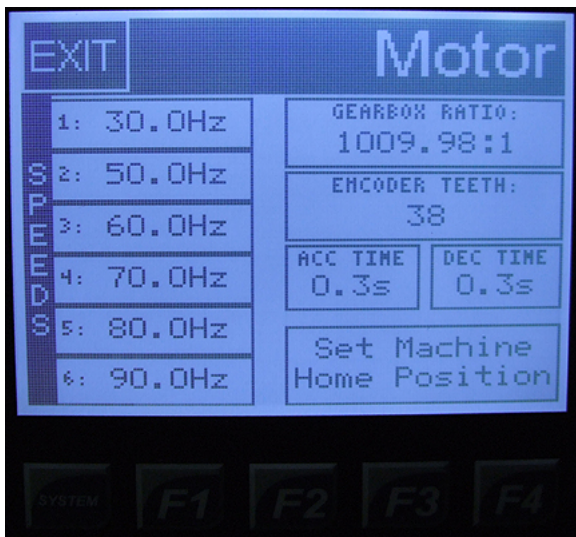

OEM Screen Figure 16

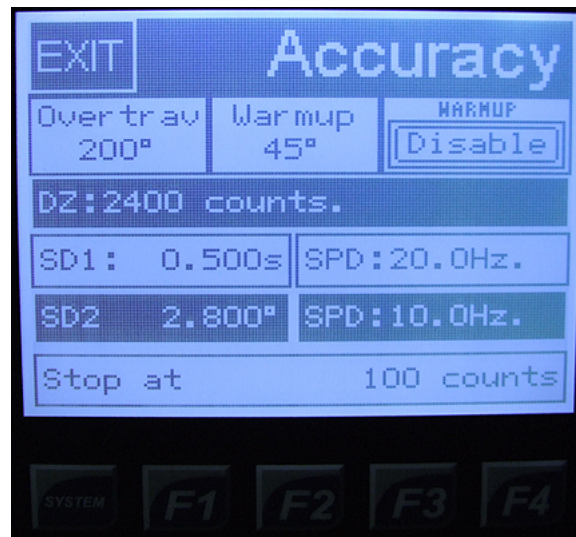

OEM Screen Figure 17

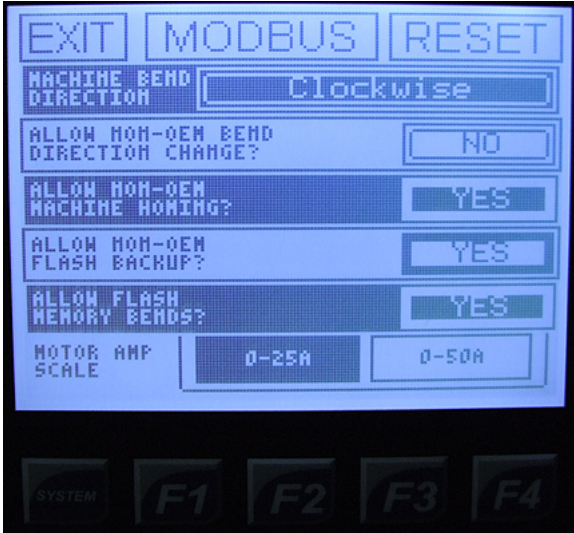

OEM Screen Figure 18

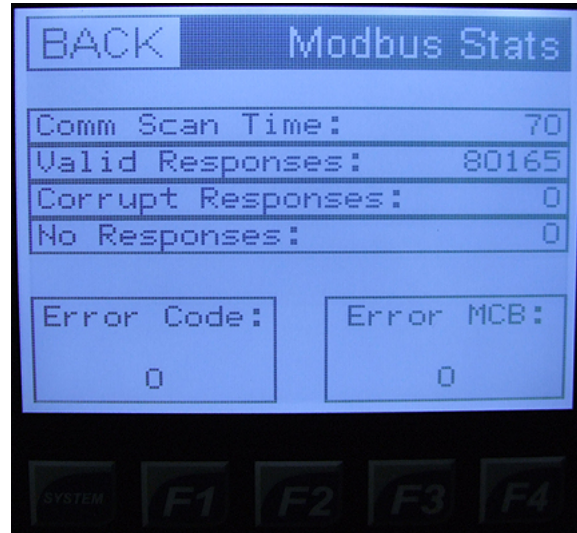

OEM Screen Figure 19

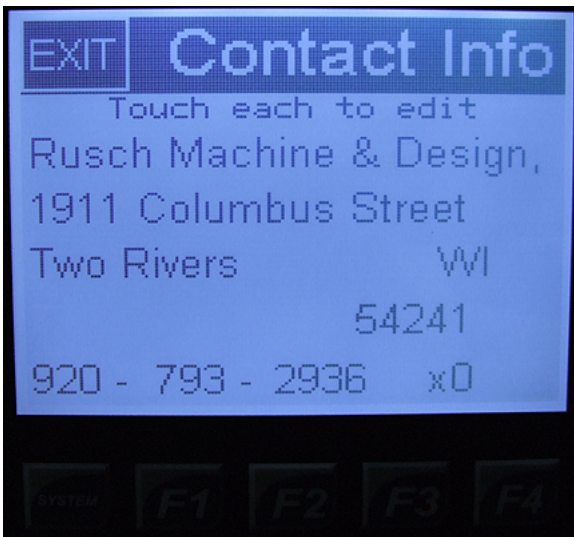

OEM Screen Figure 20

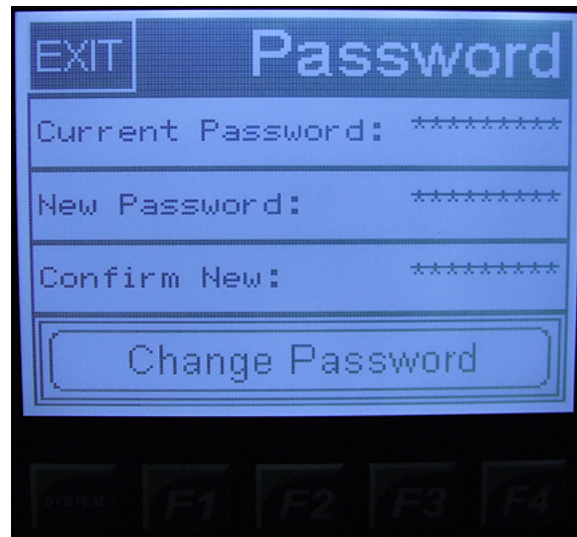

OEM Screen Figure 21



OEM Screen Figure 22





## UNDERSTANDING SPRINGBACK

Springback can be difficult to understand. As material is bent, the materials yield strength resists being formed. As a final degree is reached, the machine will have enough power to hold the bend at a set degree, but as the pressure of the machine is released, the material has a resistance built in, so it “springs back”

Springback will vary with every size, type and wall thickness, so it will never be consistent from size to size.

The best way to determine a materials springback is to do sample bends to 90 degrees until a perfect 90 is obtained.

- At that point document the actual machine degrees.
- Full manual mode is the best place to do these tests.
- Use the overbend amount and enter that value into the springback field.

## MATERIAL SELECTION

 **CAUTION:** It must be determined by the customer that materials being processed through the machine are **NOT** potentially hazardous to operator or personnel working nearby.

When selecting materials keep these instructions in mind:

- Material must be clean and dry. (without oil)
- Material should have a smooth surface so it processes easily.
- Dimensional properties of material must be consistent and not exceed the machine capacity values.
- Chemical structure of material must be consistent.
- Buy certificated steel from the same vendor when possible.



## DIE SELECTION AND INSTALLATION

Before any bending can take place, the proper die set must be chosen to match the material being bent. (EX) 1-1/2" diameter tubing requires a die set marked 1-1/2" tube.

- A Hook Arm
- B Bend Die
- C Hold down Bolts
- D Plastic Slide
- E Counter Die Mount
- F Bronze Counter Die Insert
- G "0" Mark



**Note:** Pipe and Tube are not the same, (see table 1) for nominal pipe sizes. All BAILEIGH INDUSTRIAL dies are color coded to avoid confusion between pipe and tube (see table 2).



**IMPORTANT:** Damaged or worn tooling should be replaced before attempting to bend material. This will ensure that bends are correct and provide a longer life to machine components. When handling large heavy material, make sure it is properly supported.

1. To install the die, slip the die over the centering pin until the three unequally spaced drive pins engage the receiving holes formed in the die.



**Note:** The die will only fit one way.

2. When the drive pins line up the die will drop all the way down to the spindle.
3. Install and tighten the 1/2-13 socket head bolts provided with the die. Tighten these bolts enough to hold the die firmly down to the spindle. Approximately 30-40ft-lb. (40-50N•m).



**IMPORTANT:** FAILURE TO PROPERLY BOLT DOWN DIE WILL RESULT IN DAMAGE TO MACHINE AND TOOLING.

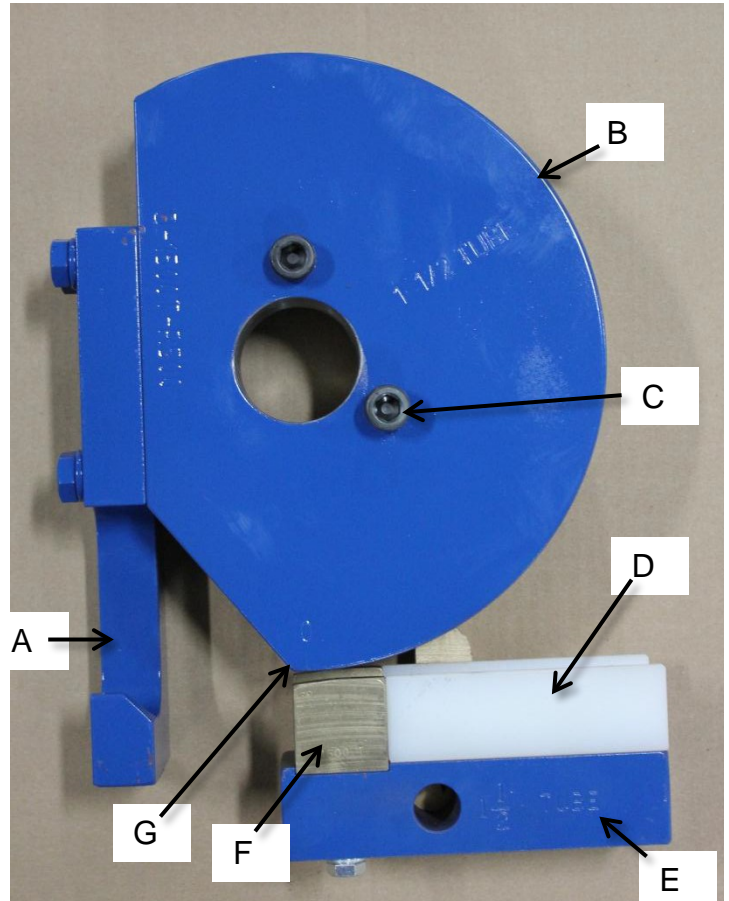



- H Spindle
- I Die Drive Pins
- J 1/2-13 Tapped holes for bolting down dies
- K Center Pin
- L At "0" position, this flat is parallel with the machine side
- M Hitch Pin

4. To install the counter die, remove the hitch pin and insert the counter die in the opening in the counter die mount until the 3/4" holes line up.
5. Now insert the hitch pin through all the holes, reinstall clip on the hitch pin with the engraved side of the counter die facing up.

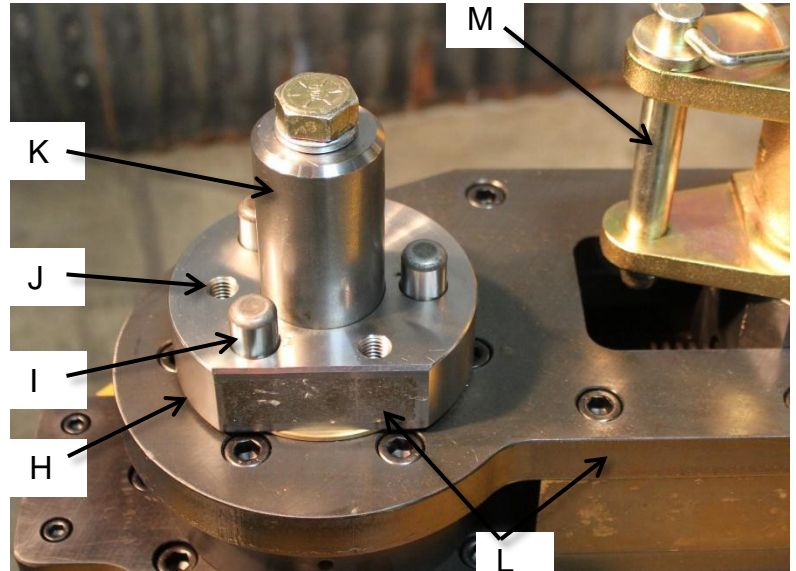

**Material Layout**

In order to create accurate parts, you will have to layout the material in flat form. First you will need to determine how much material is used per degree of bend. Use the multiplier table on Table #3 to determine the arc lengths for the die in use. Or use the following formula:

Alternate arc length formula:

Example:  $6.0 \text{ clr} \times 2 = 12$   $12 \times 3.14 = 37.699$   $37.699 / 360 = 0.1047''$  per degree  
 $0.1047 \times 90 \text{ degrees} = 9.425''$  of material used for a 90 degree bend.

Once the arc lengths are determined you can begin layout of the material using Diagram #1 as a reference.

- Diagram #1 shows a simple part bent on the same plane in the same direction.
- Diagram #2 shows bending based off of a centerline in two directions.
- For symmetrical bends, centerline bending is easiest.
- For non-symmetrical bends, continuous one direction bending is best.
- Another way to layout material is to draw them in a 2D computer software program like Auto Cad. There are many free programs on the internet. In a 2D program you will draw the parts centerline only with corresponding clr's. Then you will be able to list individual segments of the bent part. This data can be directly entered into the control.



- Another program available is BEND-TECH which is a program specifically designed for tube bending and will give you all of the required data to make a part. This software is available from Baileigh Industrial.
- Bending with a rotary draw bender requires determining the start of bend point which will line up with the “0” mark on the die. The portion of the tube toward the hook arm will be locked to the die, the portion toward the counter die is the draw side and will slide along the counter die and conform to the dies shape/radius.

### Material Insertion

1. At the RMD main menu, choose “Run/ View Edit” button and choose program to run following the on screen instructions.
2. Once the die set is properly installed and the desired program is loaded and performs as needed, the correct size material can now be inserted.
3. Lubricating counterdie and insert the material to start bending.

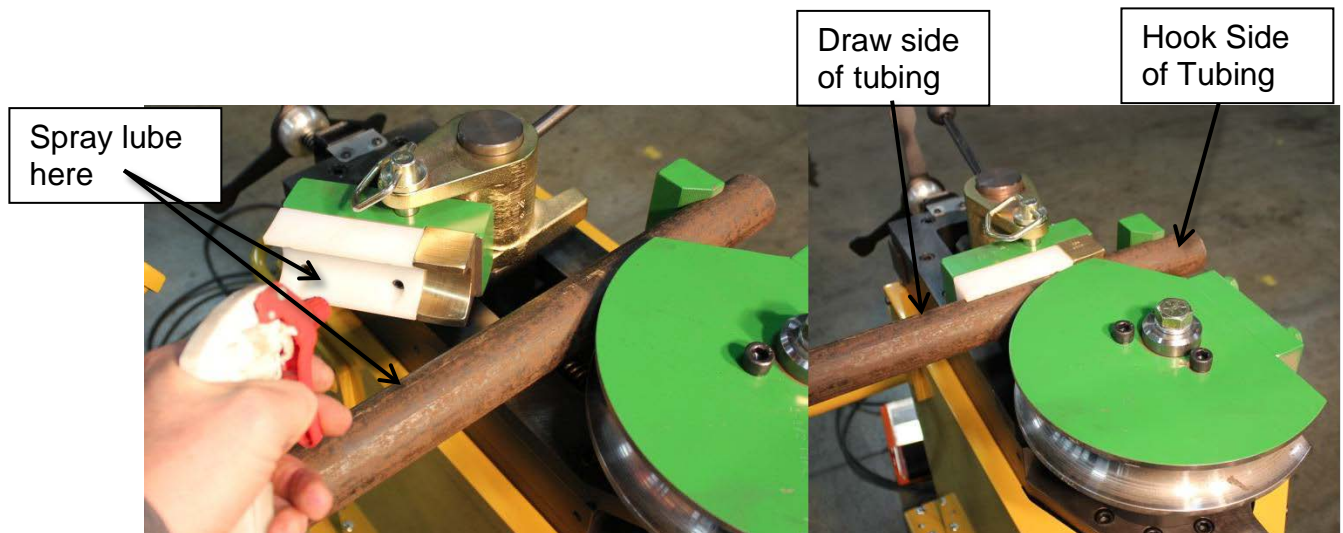

4. With the die head at home or “0” position, insert material past the hook arm aligning the “0” mark on the die with where the bend will start on the material.



**Important:** Liberally apply lubricant along the counterdie and the 1/2 of the material that contacts the counter die with a WD-40 style lubricant or equivalent. Do not lubricate the bending die. Lubricating the bending die will encourage slipping of material in the bending die.

5. Tighten the counter die assembly applying moderate pressure on the material.



6. With the counter die tight, document the number displayed on the Leadscrew counter, you will want to return to the same exact number every time to ensure exact counter die positioning and repeatable bends. This number can be entered in the control for programmed bends.

Leadscrew counter, document this position in the controller.

7. Be sure there are no obstructions along the draw side of the material.
8. Be sure to leave enough material past the plastic slide to produce the desired bend.



Left

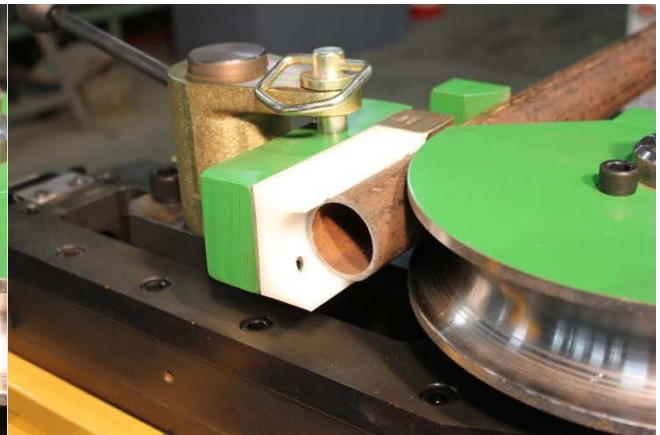

Right

The left figure shows the recommended minimum / correct amount of material remaining to be fully supported in plastic slide.

- The right figure shows the maximum amount the material can be pulled through the counter die. Pulling the material further than shown into the counter die, it will destroy the plastic slide.



Left

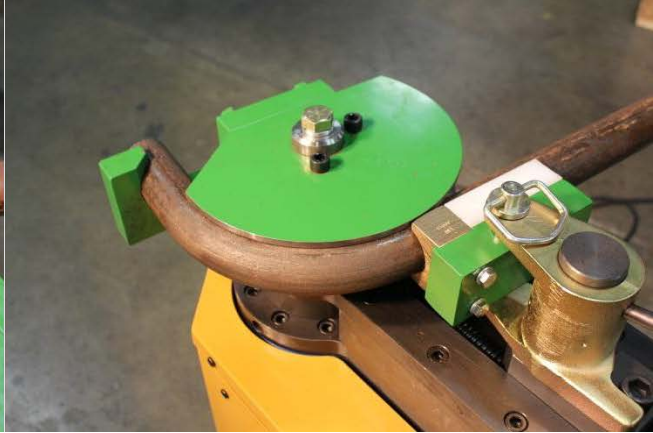

Right

- In the left figure, there is not enough material to complete the bend. This bend will damage the dies.
- The right figure shows a correct bending orientation.



**IMPORTANT:** Orienting your tubing in this fashion will cause damage to your tooling and machine!! DO NOT pull bent tubing into the counter die! Make sure you have enough straight material on the draw side of the tube to create your bend.

### **Material Removal / Advancement**

1. After the die stops at the desired angle, the material needs to be removed or advanced.
2. Activate the reverse foot pedal. As the die starts going backwards, the counter die and its quick release will swing out of the way allowing for easy material removal.
3. Activate the Reverse foot pedal and hold until the die reaches its home or "0" position. If you are advancing the material, open the counter die and then reverse machine, holding the material in place. Be careful when reversing with material still in die, not to catch it on the hook arm of the die. Once the die is at the home position, the material can be removed or advanced.
4. Repeat previous steps for next bend in line.



## PIPE AND TUBE BENDING DIAGRAMS

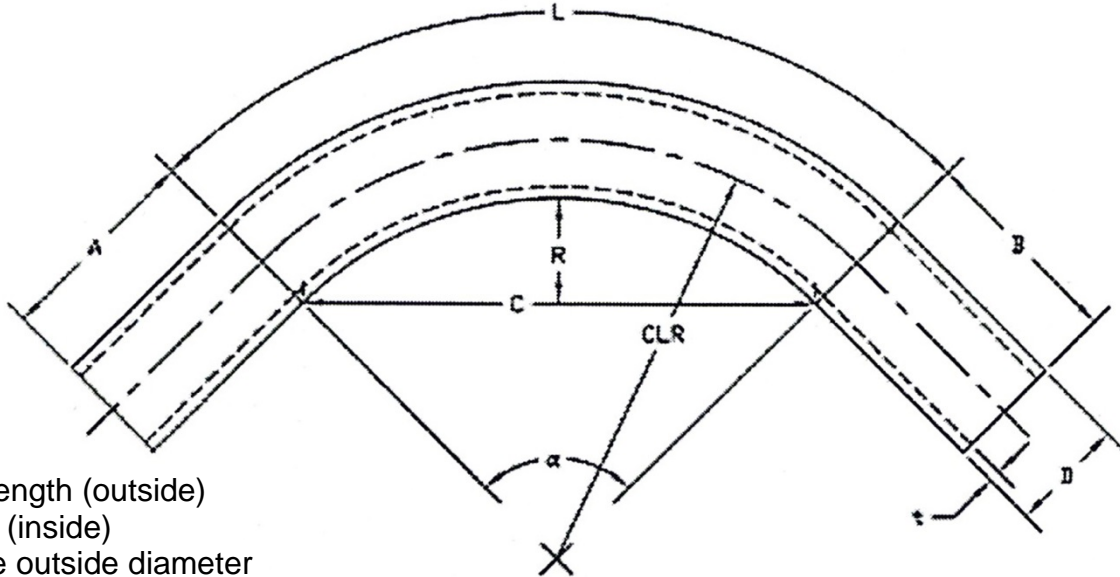

$L$  = Arc length (outside)  
 $R$  = Rise (inside)  
 $D$  = Tube outside diameter  
 $t$  = Tube wall thickness

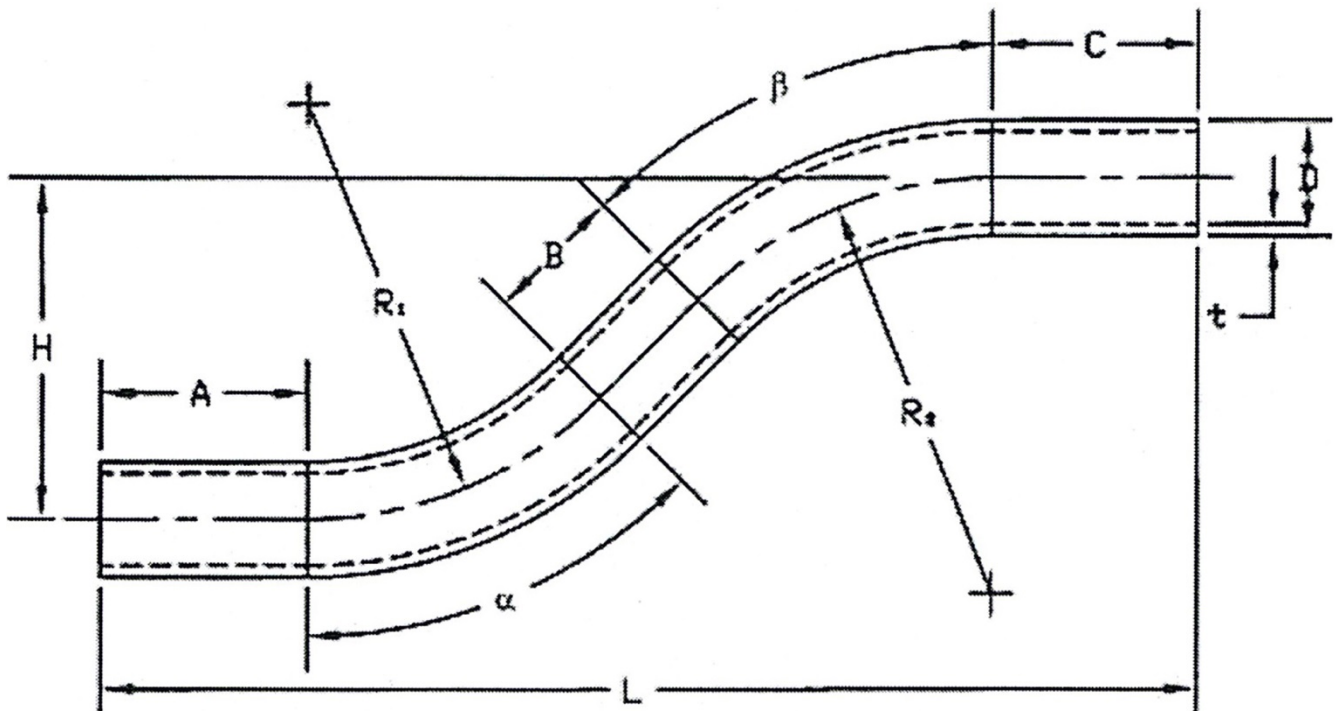

$a$  = First bend arc angle  
 $b$  = Second bend arc angle  
 $A$  = First tangent  
 $B$  = Straight between bends  
 $C$  = Second tangent  
 $D$  = Tube outside diameter  
 $H$  = Height of offset  
 $L$  = Length of offset  
 $R_1$  = First radius  
 $R_2$  = Second radius  
 $t$  = Tube Wall Thickness



## **BENDING GLOSSARY**

Arc Length	The length of material along the centerline of the tubing
Centerline Radius (CLR)	Distance in inches from the center of curvature to the centerline axis of the tube bending or pipe bending bends. Abbreviated as CLR. See Tube Bending and Pipe Bending Diagram
Degree	Angle in degrees to which the tube/pipe bends are formed (i.e. 45 degrees, 90 degrees, 180 degrees, etc.)
Easy Way (EW)	Bending of a rectangular tube with its short side in the plane of the tube or pipe bend
Hard Way (HW)	Bending of a rectangular tube with its long side in the plane of the tube or pipe bend
I.D.	Inside diameter of the tube or pipe bends
Minimum Tangent	The minimum straight on the end of pipe bends required by the bending machine to form the bend
Neutral Axis	That portion of the pipe or tube that is neither in compression or tension.
O.D.	Outside diameter in inches of the tube or pipe
Out of Plane	The deviation of the horizontal plane of a single pipe bend between its tangent points, based on the theoretical center-line of the pipe bend
Ovality	The distortion or flattening of pipe or tube from its normal, round shape caused by the pipe bending process
Springback	Amount of degrees material will return after bending pressure is released
Tangent	The straight portion of material on either side of arc of bending bends. See Tube Bending and Pipe Bending Diagrams.
Tangent Point	The point at which the bend starts or ends. See Tube Bending and Pipe Bending Diagrams.
Wall	The thickness in inches of tubular pipe bending material.
Wrinkles	Waving or corrugation of pipe bending bends in the inner radius.





## **BENDING SUGGESTIONS**

### **Aluminum Bending**

If bending aluminum, lubrication is very important, if the results are less than desirable with WD-40 other lubricants can be used such as:

- Johnson Paste Wax (seems to work the best)
- High Pressure grease
- Highly rich dish soap
- The bronze counter die must be polished and have no aluminum deposits or it will continue to pick up metal.
- If using BAILEIGH INDUSTRIAL's standard counter die is not producing desired results, roller counter dies are also available.
- BAILEIGH INDUSTRIAL has both steel rollers as well as plastic rollers. Plastic rollers are used primarily for polished aluminum. Steel rollers would be used for non-polished materials.
- Some aluminum will crack as it is being bent, 6061-T6 is very hard and may need to be annealed or ordered in the "T-0" condition. Aluminum will age harden so if possible try to get freshly run material.

### **Heavy Wall DOM tubing**

If heavy wall materials are bent to a tight radius, they can tend to slip in the hook arm causing a poor bend result, below are some suggestions

- Use a vise clamp on the outside of the hook arm to "lock" the material in place.
- Use a piece of two sided coarse emery cloth in between the hook arm and the material, this works very well.
- In only this application, high pressure grease applied to the DIE GROOVE also helps.
- BAILEIGH INDUSTRIAL can make special clamps to hold material in place.



## Bending With Square Dies

- Die Parts

- 1 Main Bending Die
- 2 Die Cap
- 3 Quick Release Handles
- 4 Hook-Arm
- 5 Hook-Arm Clamp
- 6 Plastic Slide
- 7 Slide Mount
- 8 Quick Release Studs

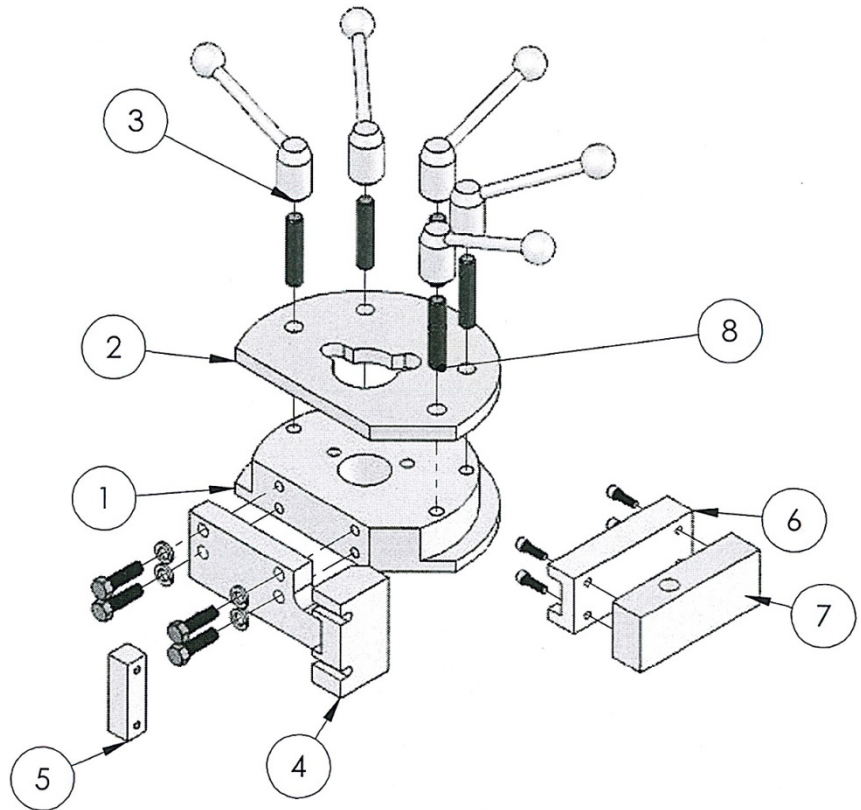

## Square Tooling Setup

1. Install the bending die (1) on to the spindle. Be careful not to pinch your fingers as you lower the die on to the spindle. The die will only fit on the spindle one way. Bolt the die to the spindle using the holes in the die.
2. Install the plastic counter die assembly (6, 7) with the long end pointing away from the hook arm.
3. Snug up the cap clamps (3). Do not over tighten! Or they will be overly difficult to loosen after the bend is complete. Note: tighten clamps without material in the die. The clamps are lift and turn, so you can position them anywhere. This allows the handles to clear the counter-die mount during bending.
4. Insert the material in to the hook arm (4) and pull in to the die. It may be a tight fit. Continue to pull until the material is fully seated in the die's groove.
5. Lube the counter die and the material that will slide along the counter die. Bring the plastic counter die assembly up to the material, leaving about 1/8" to 1/4" gap. (Note: on some thinner material it helps to keep the counter die approx. 1" away from the material)



**IMPORTANT:** Do not lube the bending die surfaces. This will increase the possibility for slippage. Make sure all the die cap clamp handles (3) are inside the die diameter. They could catch the counter die mounting assembly and break off.



6. If the material slips during the bending operation, install the hook arm clamp (5). Do not use it unless you have to.
7. Activate the bender and bend to the desired angle.
8. To remove the material, open the counter die and return bender to the "home position". Using a soft mallet, gently tap the cap clamps open and the material will spring out of the die (1). Remove the material and re-slug the cap clamps.
9. Install the next piece of material to be bent and repeat these steps.

### **Large Size Square**

When bending larger than 1.5" (38.1mm) thinner wall square tubing, the counter die position seems to work better between 1/2" and 1" (12.7-25.4mm) farther away from the die. This seems to reduce side wall distortion and inner wrinkling. Although this suggestion is to help on large size, the same steps can be used for any square, if trying to achieve better results. If the square material slips in the hook arm, use the supplied clamp and bolts to hold in place.

BAILEIGH INDUSTRIAL offer crush bend dies to form a concave crease on the inside of square bends to reduce the possibility of wrinkling.



## **INDEX TABLE ATTACHMENT (OPTIONAL EQUIPMENT)**

### **Introduction**

The IDX-10 Indexing table was designed to allow you too accurately and repeatedly position distances between bends, by using the adjustable stops. Also the IDX-10 can be used to hold the material being bent perfectly level while bending, or altering the angles between bends.

### **Connection to Your Machine**

1. Remove the shaft mounting bracket [#2] (angle iron) leaving the slide shaft [#16] in place.
2. Slide the front of the main track tube [#1] onto the slide shaft [#16].
3. Reattach the shaft mounting bracket [#2] and tighten bolts.
4. With the front of the main track tube attached, lift up the rear and support it with a sturdy saw horse or equal.
5. Attach the rear leg adjuster [#13] using the supplied 3/8 X 1" bolts.
6. Align the keyways with the slide bolt and slip the caster mount [#12] onto the leg adjuster [#13].

### **Height Adjustment and Leveling**

1. Level your machine on a flat hard surface. The Model 250 comes standard with wheels and casters. It may be necessary to fasten or lock the machine in place to keep the machine from rotating instead of the index table. (The index table must be allowed to pivot and rotate with its wheels.)
2. With the machine level, choose the desired die set.
3. The thickness of the die determines the height of the index table. Using the table to find the correct number of turns required for your die.
4. Rotate the height adjustment screw [#21] clockwise until it stops. This is the lowest the table will go. (EXAMPLE 1-1/2 die)
5. Rotate the adjustment screw [#21] counter clockwise the exact number of turns that were chosen from the chart.
6. Using a 2 ft. level placed on the main track tube, rotate the large nut [#35] until the main track tube is level.
7. Position the front of the main track tube so the center line of the track tube matches the center (radius) line of the die.

Height Adjustment	
Counter-Clock Wise To Raise	
Turns CCW	Die Thickness
0.0	1.50
2.5	2.00
5.0	2.50
7.5	3.00
10.0	3.50



8. The Chuck/Gearbox assembly is designed to pivot on its mount, tension is adjusted with spring washers beneath the (2) ½-13 mounting bolts. For small light weight material, the swivel will need to be loosened so it pivots easily, for heavy material, the swivel should be tightened to increase resistance.

### **Material Layout**

Before you can use the IDX table, the bend positions of your first piece of material needs to be laid out. Using Diagram1 and Table1 you can determine all of the bend start points, these points should be transferred to the material using a fine point sharpie marker. This diagram is a generic two bend scenario, for more complex parts the steps are generally the same. Use Material Layout section for further reference.

### **Operation**

1. After the connection to your machine is complete, and the height and center line positions are verified, the IDX-10 can be used.
2. Your first part should now be clearly marked. These marks will be used to position the tubing perfectly with the "0" mark on the die, and to set your IDX stops. Only your first part needs to be marked, after that the IDX stops will be used.
3. Insert a piece of material through the hook arm of the die being used and insert through the chuck. (note: If multiple parts are being produced, the material should be marked so the linear chuck position can be repeated) position the material so the start of bend mark lines up with the "0" mark on the die, now set your first stop on the index table and produce the first bend. NOTE: The complete table will swing, be sure not to interfere with the motion.
4. After the bend is complete, the die must return to home. Once the die is home, the material can be advanced and rotated (if required) to the next "0" mark. The next stop can now be set. Repeat as required, your IDX table comes standard with (4) stops.

 **IMPORTANT:** Make sure the hook arm of the die does not catch the tubing when returning to home position.

5. The previous steps are just examples how to set stops and produce various bends; it is up to the user to define exactly how their IDX will be set up. BAILEIGH INDUSTRIAL will be glad to offer any suggestions for your application.



## INDEX TABLE LAYOUT DIAGRAM (OPTIONAL EQUIPMENT)

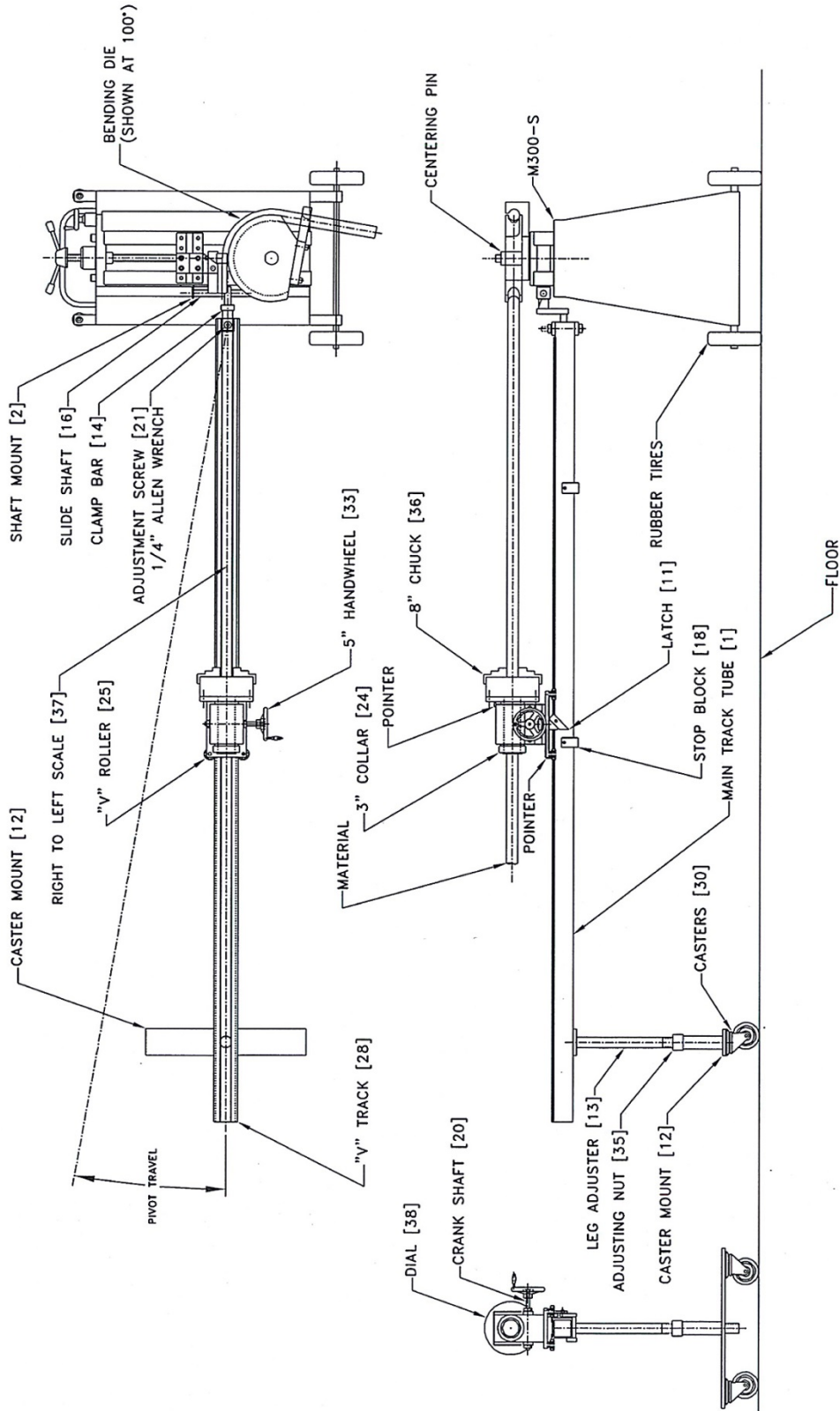



## LUBRICATION AND MAINTENANCE



**WARNING:** Make sure the electrical disconnect is OFF before working on the machine.

Maintenance should be performed on a regular basis by qualified personnel.

Always follow proper safety precautions when working on or around any machinery.

- Check daily for any unsafe conditions and fix immediately.
- Check that all nuts and bolts are properly tightened.
- On a weekly basis clean the machine and the area around it.
- Lubricate threaded components and sliding devices.
- Apply rust inhibitive lubricant to all non-painted surfaces.



**Note:** *Proper maintenance can increase the life expectancy of your machine.*

### Gear Box Oil

The main Planetary Gear Box is lubed with 80W90 gear lube. Check and replace the gear lube every 3 years or 200hrs of continuous use.

### Main Spindle Bearing

The only grease fitting on the bender is the main spindle bearing zerk fitting. Pump with 3-4 shots every month or 10hrs of continuous use.



# ELECTRICAL SCHEMATIC

Horner ( XLE or XLT)  
Hexle 102 or HE-XT102  
Programmer

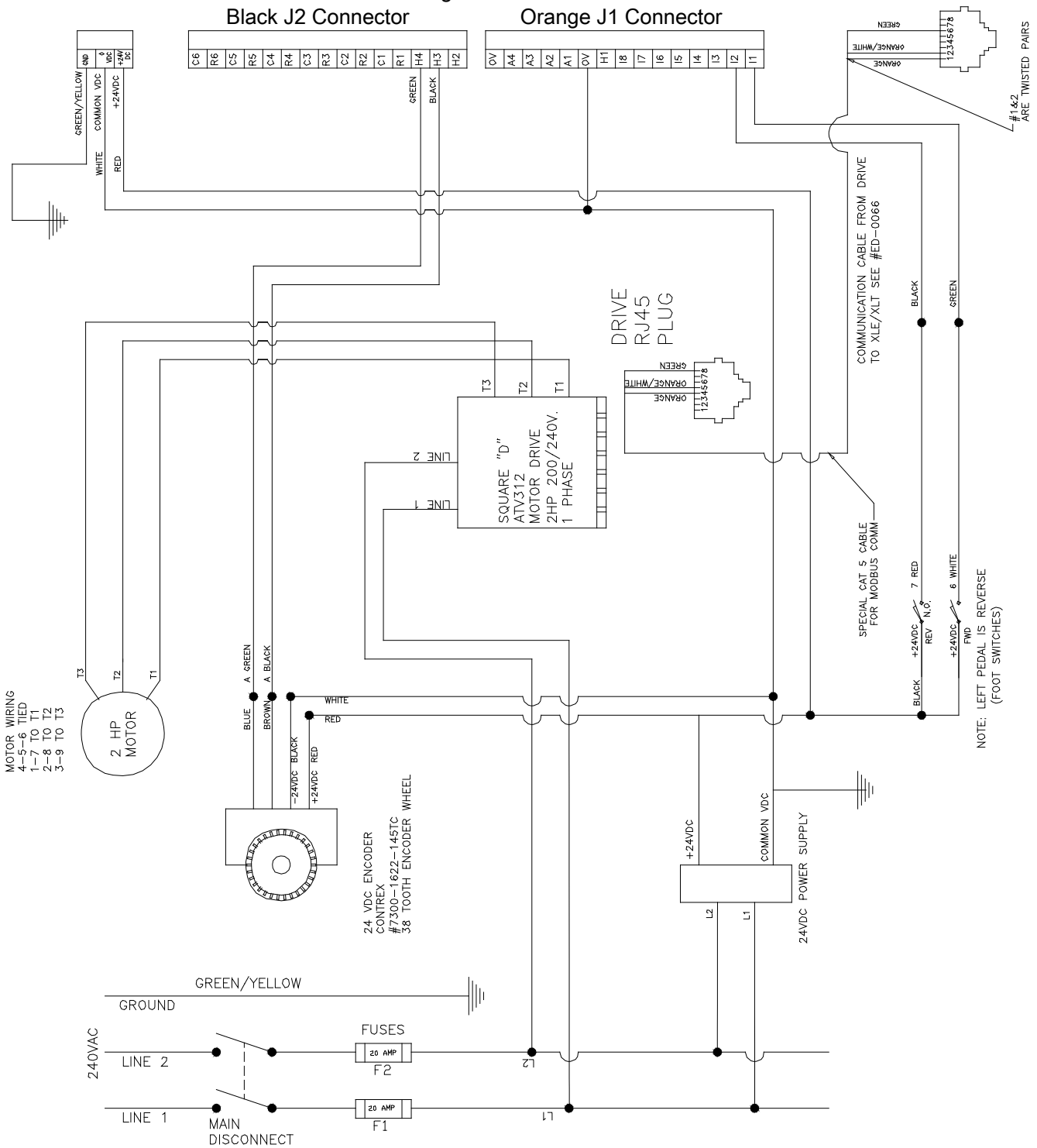

NOTE: LEFT PEDAL IS REVERSE (FOOT SWITCHES)





## Electrical Components

**⚠ WARNING:** Make sure the electrical disconnect is OFF before working on the machine. Use the lockout provided on the main disconnect switch. Wait at least 1 min before working on any circuit, because the VFD capacitors may have energy stored. Maintenance should be performed on a regular basis by qualified personnel. Always follow proper safety precautions when working on or around any machinery.

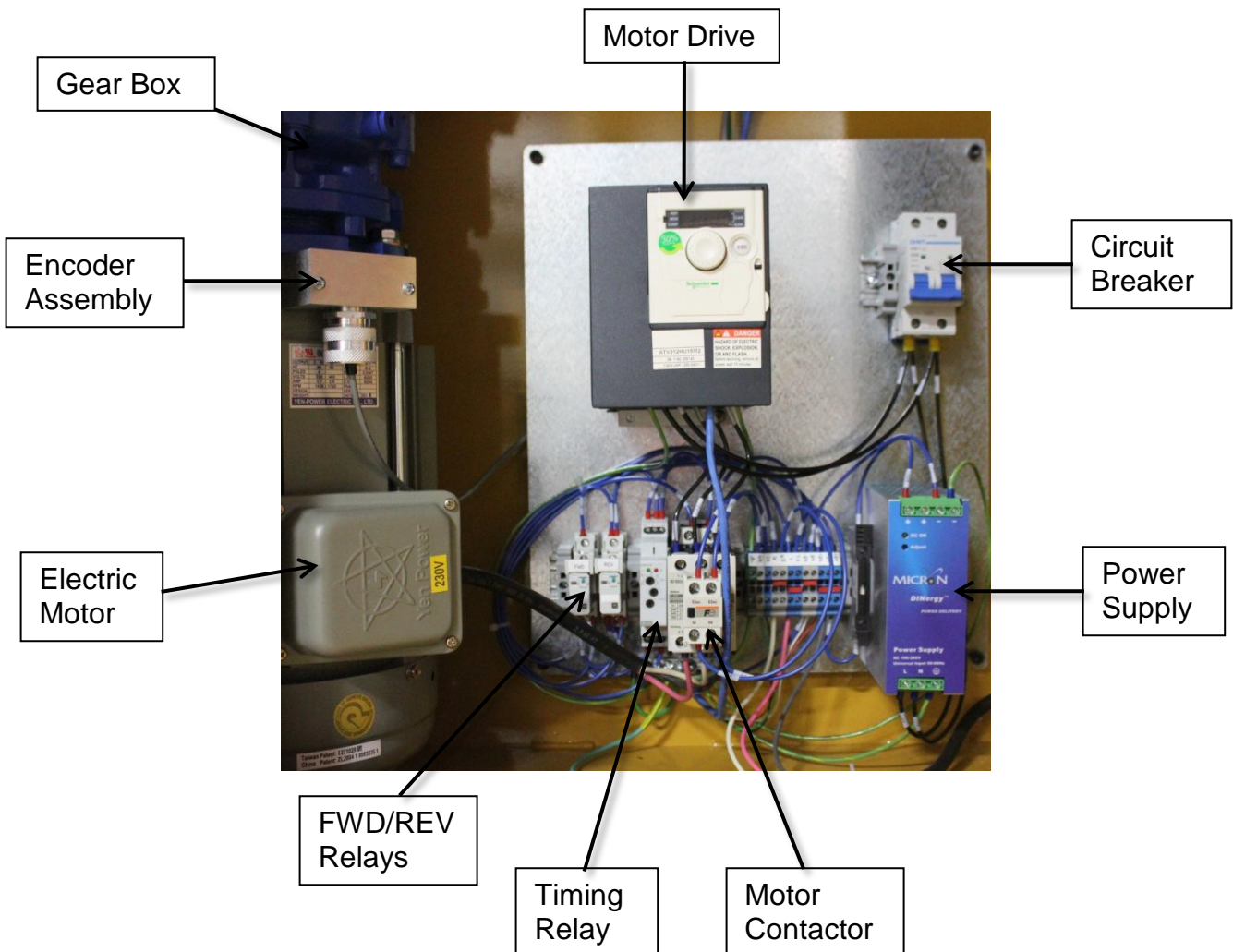



## TROUBLESHOOTING

FAULT	PROBABLE CAUSE	REMEDY
Machine does not power up	Wrong or non-existent input power source. Blown fuse or tripped circuit breaker.	Check input power and verify voltage Check and replace fuses. Reset circuit breakers
Oil leaking from breather	Normal expansion of gearbox oil	Let oil purge from gearbox and take no further action.
Home position is not in correct position.	Loss of power during bending, or service work was performed	Go to homing screen on controller and repeat homing sequence. If not accessible, contact factory.
Material slips in hook arm	Too much oil on tubing or oil is on the die groove. Clear Radius is too tight. Material has too thin of wall thickness.	Clean material and die groove with solvent. Increase clear radius. Increase wall thickness. Material may need to be clamped top hook arm to prevent slipping. Only the counter die should be lubed
Poor bend results	Worn counter die. Worn die groove. Wrong size material and or wall thickness. Too tight of a clr.	Replace counter die. Replace die. Verify material size is correct. Verify clr
Twisting material	Bend die is not bolted down, Misaligned counter die, worn spindle bearing	Verify the bend die is bolted down to the spindle. Check counter die alignment. Replace spindle bearing
Machine overloads and wont bend	Material is too big for machines capacity. Tensile strength of material is too high. Input power is too low. Bending speed is too fast. No lube on counter die.	Verify material wall thickness and diameter for capabilities. Get material with lower tensile strength. Lower bend speed. Verify input power.
Inaccurate bending	Counter Die leadscrew position is changing. Material diameter is not consistent	Verify that the counter die leadscrew is holding its position via the counter. Check material diameter with a caliper to verify size.



## TABLES, CHARTS, & DIAGRAMS

**Table 1 Standard Pipe Sizes and Schedules**

PIPE SIZES	O.D.	Pipe Schedules and Wall Thickness					
		5	10	40	80	160	XX STRONG
1/8	0.405	0.400	0.050	0.068	0.095		
1/4	0.540	0.500	0.070	0.088	0.119		
3/8	0.675	0.500	0.070	0.091	0.126		
1/2	0.840	0.700	0.080	0.109	0.147	0.188	0.294
3/4	1.050	0.700	0.080	0.113	0.154	0.219	0.308
1	1.315	0.700	0.110	0.133	0.179	0.250	0.358
1-1/4	1.660	0.700	0.110	0.140	0.191	0.250	0.382
1-1/2	1.900	0.700	0.110	0.145	0.200	0.281	0.400
2	2.375	0.700	0.110	0.154	0.218	0.344	0.436
2-1/2	2.875	0.800	0.120	0.203	0.276	0.375	0.552

**Table 2 Die Color Code Chart**

Material	Color
Pipe	Green
Tube	Blue
Metric	Red
Square or Rectangle	Gray



**Table 3 ARC LENGTH TABLE**

EXAMPLE: Arc Length = Constant x Bend Radius. Example: 90deg bend with 6" clr

EXAMPLE: 1.575 (from table) x 6" (clr) = 9.45" (Arc Length)

For bends more than 90deg, Constants can be added together.

Degrees	Constant	Degrees	Constant	Degrees	Constant
1	0.0175	31	0.5410	61	1.0645
2	0.0349	32	0.5584	62	1.0819
3	0.0524	33	0.5759	63	1.0994
4	0.0698	34	0.5933	64	1.1168
5	0.0873	35	0.6108	65	1.1343
6	0.1047	36	0.6282	66	1.1517
7	0.1222	37	0.6457	67	1.1692
8	0.1396	38	0.6631	68	1.1866
9	0.1571	39	0.6806	69	1.2041
10	0.1745	40	0.6980	70	1.2215
11	0.1920	41	0.7155	71	1.2390
12	0.2094	42	0.7329	72	1.2564
13	0.2269	43	0.7504	73	1.2739
14	0.2443	44	0.7678	74	1.2913
15	0.2618	45	0.7853	75	1.3088
16	0.2792	46	0.8027	76	1.3262
17	0.2967	47	0.8202	77	1.3437
18	0.3141	48	0.8376	78	1.3611
19	0.3316	49	0.8551	79	1.3786
20	0.3490	50	0.8725	80	1.3960
21	0.3665	51	0.8900	81	1.4135
22	0.3839	52	0.9074	82	1.4309
23	0.4014	53	0.9249	83	1.4484
24	0.4188	54	0.9423	84	1.4658
25	0.4363	55	0.9598	85	1.4833
26	0.4537	56	0.9772	86	1.5007
27	0.4712	57	0.9947	87	1.5182
28	0.4886	58	1.0121	88	1.5356
29	0.5061	59	1.0296	89	1.5531
30	0.5235	60	1.0470	90	1.5705



**Diagram 1**

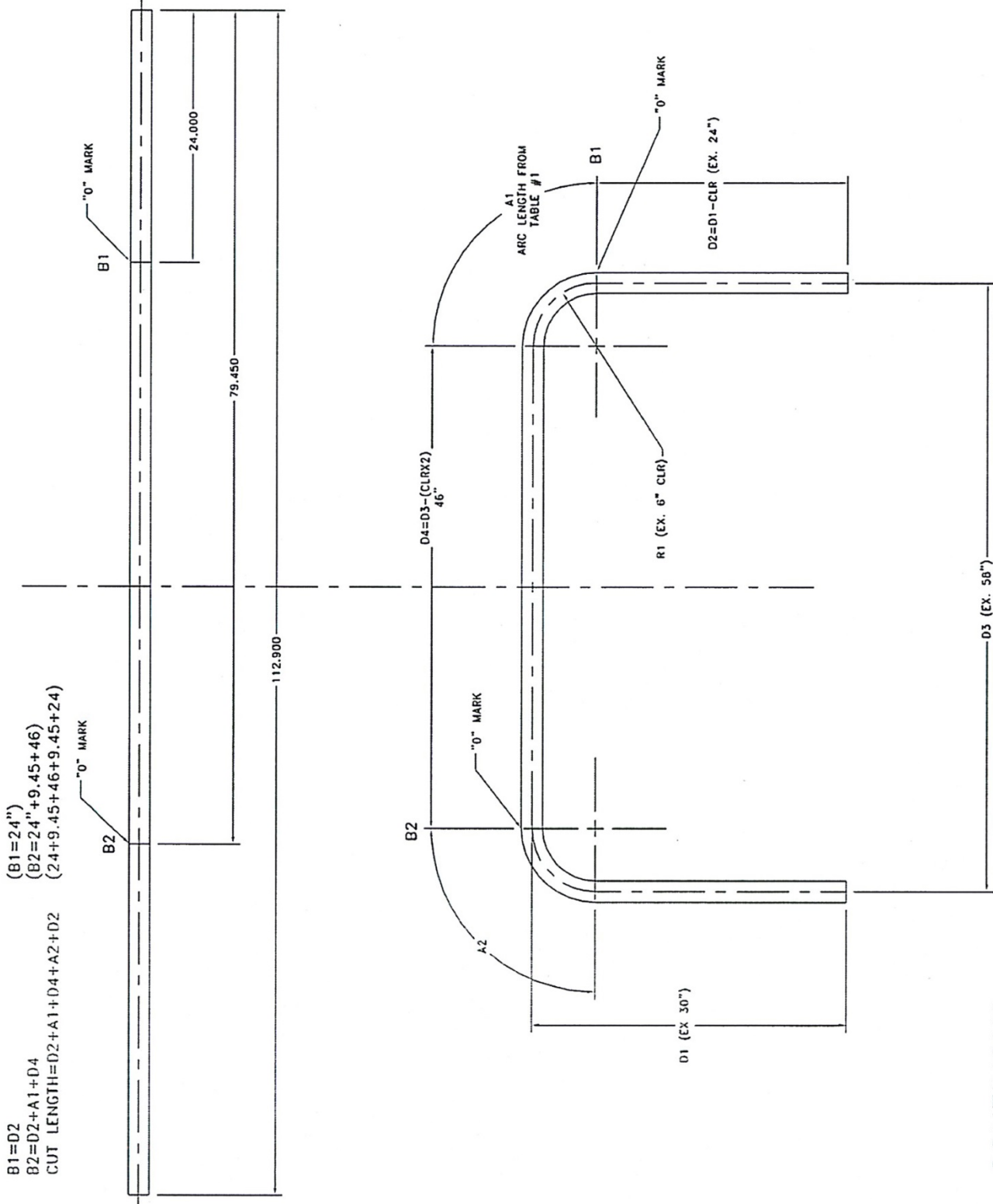

CONTINUOUS LAYOUT

DIAGRAM #1



**Diagram 2**

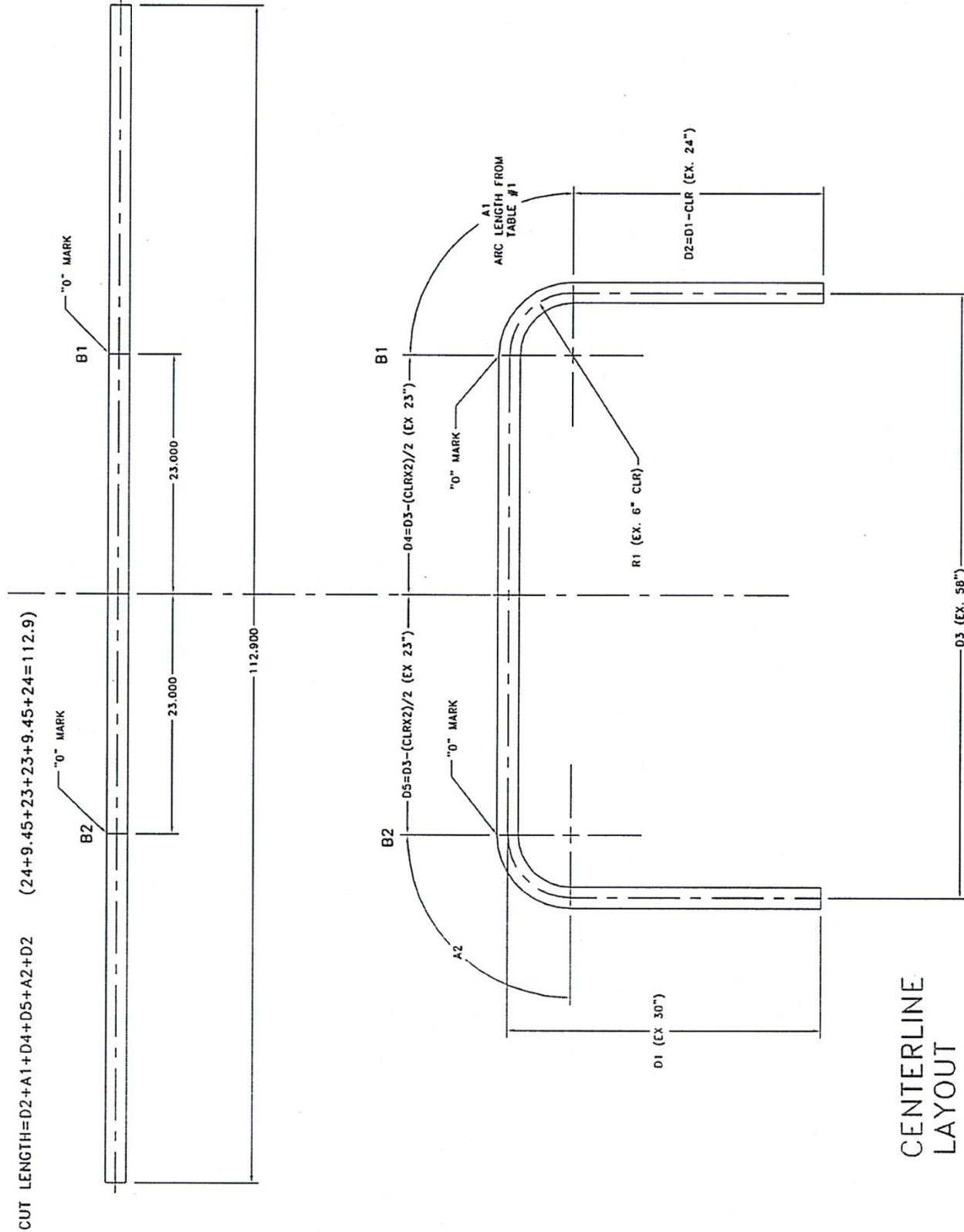

CENTERLINE LAYOUT

DIAGRAM #2



# PARTS DIAGRAM

## Base Assembly Parts Diagram

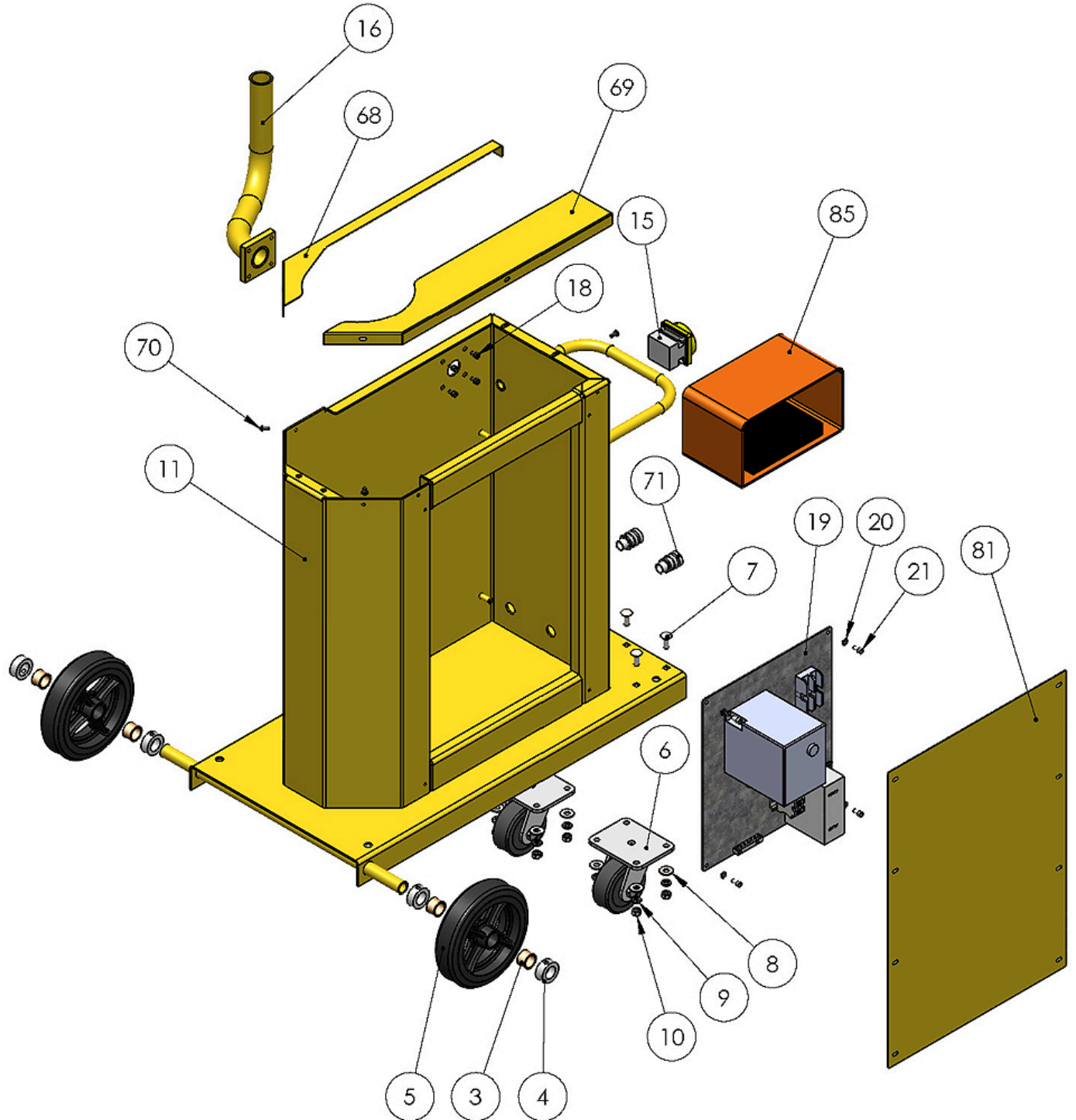



**Control Box Parts Diagram**

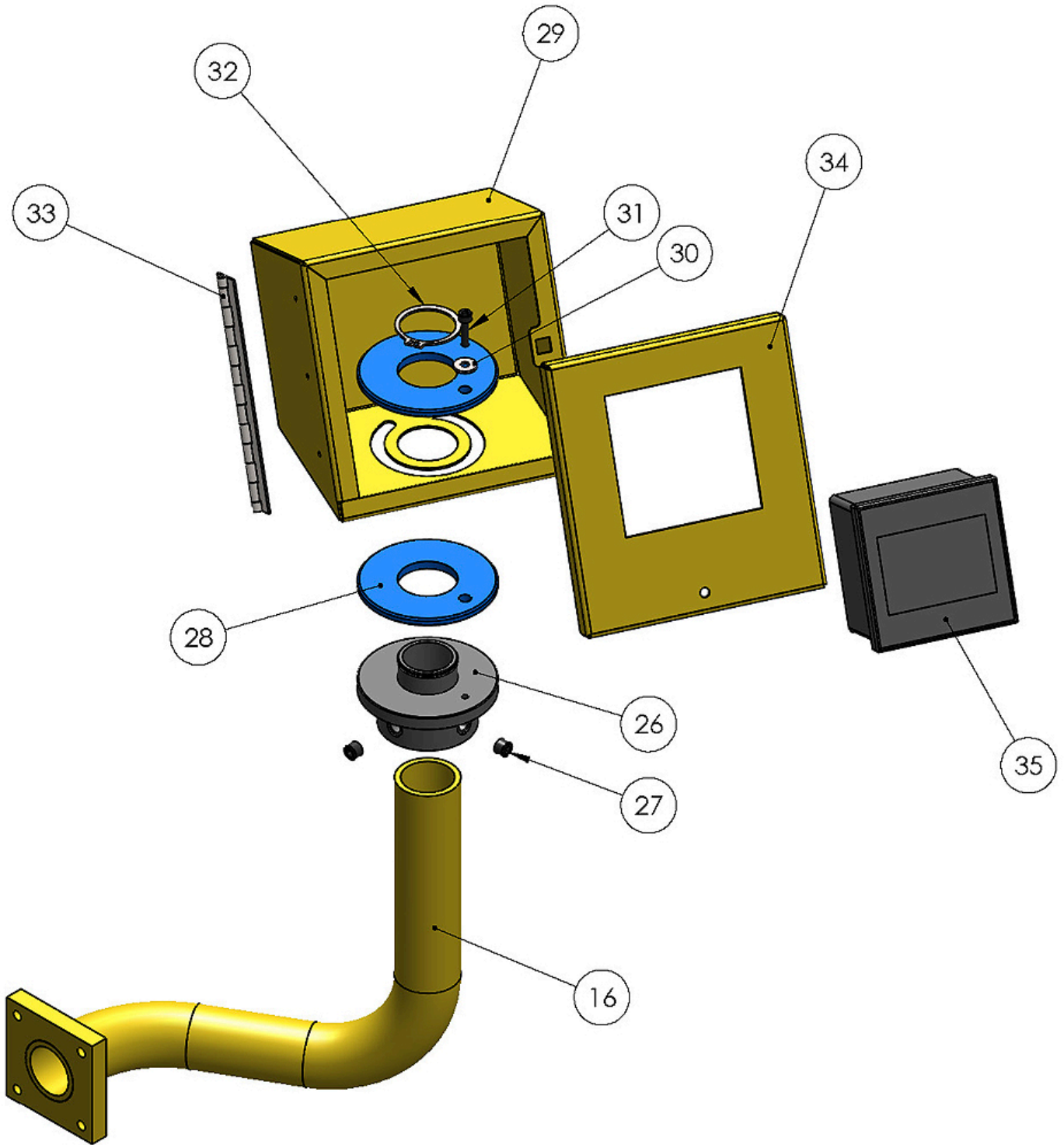





Drive Assembly Parts Diagram

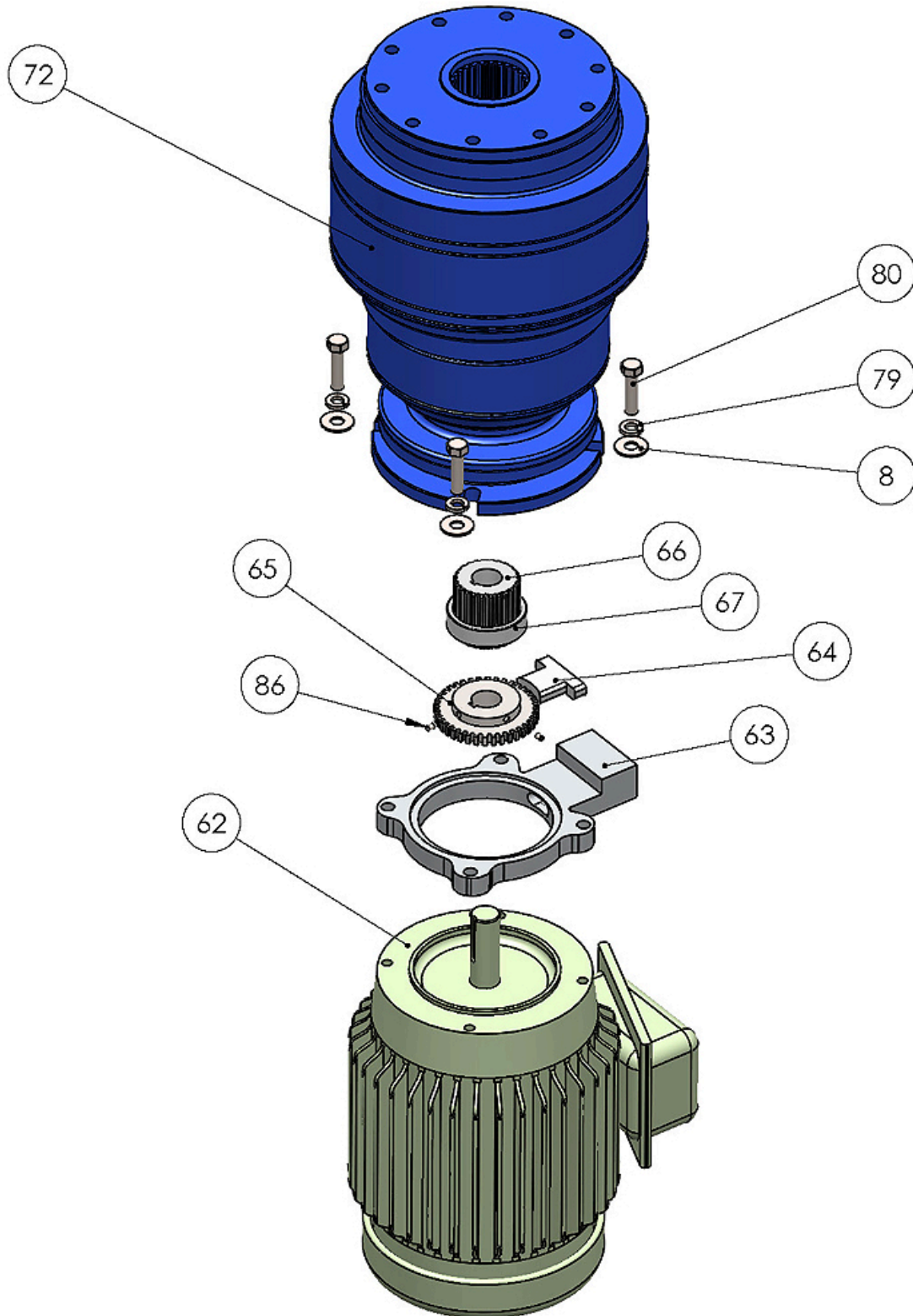



### Main Bending Assembly Parts Diagram

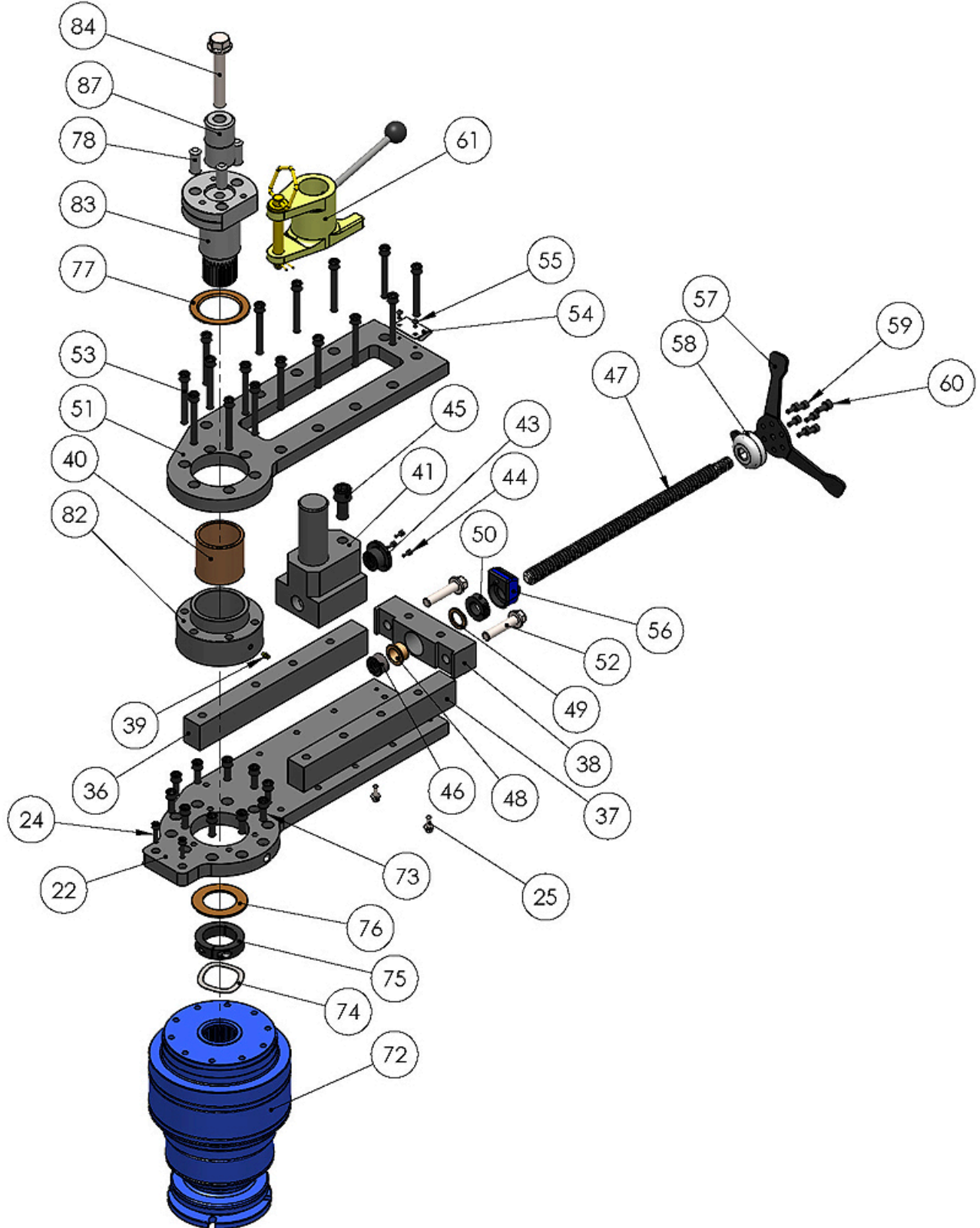



## Parts List

Item	Part Number	Description	Qty.
3	PP-0043	1.0 ID X 1.1875 OD X 0.75 LG BUSHING	4
4	PP-0035	1" SET SCREW COLLAR	4
5	PP-0064	8" RUBBER WHEEL	2
6	PP-0048	4.0 INCH CASTER	2
7	STD.	3/8-16 X 1 CARRIAGE BOLT	8
8	STD.	3/8 FLAT WASHER	12
9	STD.	3/8 LOCK WASHER	8
10	STD.	3/8-16 HEX NUT	8
11	M250-5A003	CART	1
15	PP-0304	ON/OFF 2 POLE SWITCH	1
16	M250-5A009	M250 BOX ARM	1
18	STD.	M6 X 1.0 X 10 SHCS	4
19	M250-6A016	M250 ELECTRICAL PANEL	1
20	STD.	1/4 LOCK WASHER	4
21	STD.	1/4-20 X 0.5 SHCS	4
22	ME-M250-6A009	BOTTOM PLATE ME-250	1
24	M8 X 1.25 X 30	SHCS	2
25	M8 X 1.25 X 20	HEX FLANGE	2
26	ME-M350-7A057	ELECTRICAL BOX PIVOT HUB	1
27	M10 X 1.5 X 8	SET SCREW	2
28	M350-7A058	ELECTRICAL BOX WASHER	2
29	M250-6A021	BOTTOM TOUCHSCREEN ENCLOSURE	1
30	STD.	5MM FLAT WASHER	1
31	M5 X 0.8 X 20	SHCS	1
32	STD.	1.5" EXT. RETAINING RING	1
33	M250-5A008-B	ENCLOSURE HINGE	1
34	M250-6A022	XLT SCREEN COVER	1
35	XLT CONTROLLER	XLT CONTROLLER	1
36	ME-M250-6A011	SIDE FRAME (LONG)	1
37	ME-M250-6A012	SIDE FRAME (SHORT)	1
38	ME-M250-6A013	END BLOCK	1
39	.25-28 GREASE ZERK	STRAIGHT GREASE ZERK	1
40	PP-0780	2.75 ID X 3.25 OD X 3.0 LG BUSHING	1



Item	Part Number	Description	Qty.
41	ME-M250-6A017	CENTER SLIDE BLOCK (INSERTED)	1
42	M250-7A006	PIVOT PIN	1
43	ME-M250-7A010	LEAD SCREW NUT INSERT	1
44	M5 X 0.8 X 12	SHCS	3
45	M20 X 2.5 X 40	SHCS	1
46	M250-7A009	LEAD SCREW STOP NUT	1
47	M200-7A023	LEAD SCREW	1
48	PP-0913	1.0 ID X 1.25 OD X 0.75LG	1
49	PP-0056	1.0 ID X 1.5 OD X .125 THK	1
50	PP-0036	1.0 CLAMP COLLAR (SPLIT)	1
51	ME-M250-6A010	TOP PLATE ME-M250	1
52	M16 x 2.0 x 70	HEX FLANGE	2
53	M12 X 1.75 X 90	SHCS	16
54	M250-6A015-V2	COUNTER BRACKET	1
55	M6 X 1.0 X 12	BUTTON HEAD	2
56	PP-0137-V2	FIAMA COUNTER	1
57	M300-6A066	HAND WHEEL	1
58	ME-M300-7A034	HANDWHEEL MOUNTING HUB	1
59	M8 X 1.25 X 16	SHCS	6
60	M10 X 1.5 X 20	SHCS	1
61	M150-5A001	GOLD QUICK RELEASE	1
62	PP-0173	2HP MOTOR	1
63	PP-0812	56C ENCODER BASE	1
64	PP-0812-B	ENCODER SENSOR	1
65	M250-7A007	38T RING GEAR .875 BORE	1
66	PP-0297-B	SPLINED ADAPTER HUB 1-1/8	1
67	PP-0297-A	SPACER RING	1
68	M200-REARGRD	GUARD, M325 REAR	1
69	M200-FRTGRD	GUARD, M200 FRONT	1
70	STD.	1/4-20 X 0.5 BHCS	3
71	PP-0025	CORD GRIP	2
72	PP-0297	GEAR BOX	1
73	M12 X 1.75 X 30	SHCS	10
74	PP-0819	WAVE SPRING	1
75	PP-0731	2.25"CLAMP COLLAR	1



Item	Part Number	Description	Qty.
76	M300-7A032	THRUST WASHER	1
77	M300-7A031	THRUST WASHER	1
78	PP-1071	3/4" DOWEL PIN	3
79	STD.	3/8 LOCK WASHER	4
80	STD.	3/8-16 X 16 HHCS	4
81	M200-COVER	COVER, M325 FRONT	1
82	M250-7A002	BEARING HUB	1
83	ME-M250-7A008	M250 SPINDLE (METRIC)	1
84	STD.	M20 X 2.5 X 120 HEX FLANGE SCREW	1
85	PP-0666	FOOT PEDAL	1
86	STD.	8-32 X .25 SET SCREW	2
87	ME-M300-7A003	CENTER PIN	1



NOTES



NOTES