

# TENNSMITH® USA



## MODEL PR16 POWER ROTARY

### OPERATION, PARTS & MAINTENANCE MANUAL

# TENNSMITH® USA

6926 Smithville Hwy. McMinnville, TN 37110

Phone: 931-934-2211 • Fax: 931-934-2200

Email [info@tennsmith.com](mailto:info@tennsmith.com)

[www.tennsmith.com](http://www.tennsmith.com)



Proudly Made in the USA  
A Family Tradition Since 1928



# MACHINE SPECIFICATIONS



## Model PR16

Maximum forming capacity, mild steel	16 gauge / 1,6mm
Maximum forming capacity, stainless steel	20 gauge / 1,0mm
Maximum Throat length	10 in. / 254mm
Working Speed variable	3 to 45 rpm
Motor-230, 3 phase, 60Hz	1/2 hp
Amp Draw of 3 phase motor 1/2hp	1.5 amps
Motor-230, 1phase, 60Hz	1/2 hp 230 volt 1 phase
Amp Draw of 1 phase motor 3hp	2 amps
Shipping weight	350 lbs. / 159 kg

### APPROXIMATE SHEARING, BENDING AND FORMING CAPCITIES FOR VARIOUS MATERIALS COMPARED TO MILD STEEL

Mild Steel Capacity	20ga.	18ga.	16ga.	Mild Steel Capacity	20ga.	18ga.	16ga.
NON-FERROUS METALS				FERROUS METALS			
Aluminum				Iron-dead soft	20ga.	18ga.	16ga.
1100-0, 2024-0	.070	.090	.125	Steel low carbon			
5052-0, 6061-T4	.070	.090	.125	1074, 1095 C.R. Spring Steel	24ga.	22ga.	20ga.
2024-T3, 5052-H34	.048	.063	.090	Hot Rolled	20ga.	18ga.	16ga.
5086-H36, 6061-T6	.048	.063	.090	Low carbon Cold Rolled	20ga.	18ga.	16ga.
Copper and Alloys				Stainless Steel Annealed	24ga.	22ga.	20ga.
Electrolytic Copper	18ga.	16ga.	14ga.	OTHER MATERIALS			
Bronze Commercial	18ga.	16ga.	14ga.	Plastics			
Brass 70-30	18ga.	16ga.	14ga.	ABS Compounds .120	.150	.200	
Nickel Alloys				Polycarbonate	.075	.105	.125
Inconel 600	24ga.	22ga.	20ga.	Printed Circuit Boards			
Monel R405	24ga.	22ga.	20ga.	Copper-Clad			
Nickel 200A Annealed	24ga.	22ga.	20ga.	Epoxy Laminate	.086	.115	.150
Zinc as Rolled	20ga.	18ga.	16ga.				

	<b>Approximate Gauge Equivalents</b>										
<b>Gauge</b>	<b>28</b>	<b>26</b>	<b>24</b>	<b>22</b>	<b>20</b>	<b>18</b>	<b>16</b>	<b>14</b>	<b>12</b>	<b>11</b>	<b>10</b>
<b>Inches</b>	<b>.015</b>	<b>.018</b>	<b>.024</b>	<b>.030</b>	<b>.036</b>	<b>.048</b>	<b>.060</b>	<b>.075</b>	<b>.105</b>	<b>.120</b>	<b>.135</b>
<b>Millimeters</b>	<b>.38</b>	<b>.46</b>	<b>.61</b>	<b>.76</b>	<b>1.00</b>	<b>1.25</b>	<b>1.60</b>	<b>2.00</b>	<b>2.70</b>	<b>3.05</b>	<b>3.50</b>



6926 Smithville Hwy McMinnville, TN 37110  
 Phone: (931) 934-2211 • Fax (931) 934-2220  
 Email: [info@tennsmith.com](mailto:info@tennsmith.com)  
[www.tennsmith.com](http://www.tennsmith.com)

## **FOREWORD**

**This manual has been prepared for the owner and operators of the TENNSMITH Model PR16 POWER ROTARY.**

Its purpose, aside from operation instruction, is to promote safety through the use of accepted operating procedures. Read all instructions thoroughly before operating your machine.

Also contained in this manual is the parts list for your PR16. It is recommended that only TENNSMITH factory authorized parts be used for replacement parts.

## **WARRANTY**

The Model PR16 has a three year limited warranty from the date of purchase. The terms of the warranty are stated on the warranty registration card shipped with your machine. Please complete and return this card to activate your warranty.

## **SAFETY**

1. Each employee involved with the installation, operation and maintenance with this machine must review and understand the section of the manual entitled safety.
2. Always disconnect the machine from the main power supply prior to any maintenance and repair work to the machine.
3. The machine must only be operated by authorized personnel that have been trained and fully understand the operation of this machine.
4. To ensure that there are no conflicts of authority, responsibilities for machine operation and maintenance must be clearly defined and carried out by trained personal, prior to the installation and regular operation of this machine.
5. The operator must ensure that no unauthorized personnel work with this machine with regard to either operation or maintenance.
6. Electrical hazards such as shock exist with this machine. All work regarding electrical installation and maintenance must be performed by dully-trained personnel. Before initial connection, check to verify that the operating voltage on the label attached to the electrical box complies with the main voltage of the electrical connection used for this machine.
7. All safety devices and labels must not be removed from the machine
8. The work area around the machine must be clear of obstructions, which could interfere with the proper operation of the machine.
9. The main electrical supply line must be disconnected prior to any work performed inside the electrical cabinet. Proper lockout procedures must be performed to ensure that the main electrical supply cannot be activated during any work performed inside the electrical box.
10. Modification or conversion of this machine is prohibited.

11. The operator of this machine must ensure that non-authorized personnel cannot operate the machine. Lock out tags must be used on the main disconnect while the machine is unused by the trained and authorized personnel.
12. The operator of this machine must ensure that his hands and body parts do not enter the area of the forming rolls when the machine is in use.
13. **Danger!** Maintain a safe distance from the machine when it is activated. Hands and fingers can be crushed. Wear protective clothing and work boots while operating the machine. Do not wear loose clothing, rings or any jewelry while operating this machine. Work gloves should only be used outside of the danger area of the forming rolls.
14. The operator must review the machine and work area for any possible hazards prior to operating the machine. Any hazards must be reported to the proper personnel.
15. Use work-holding devices such as tongs for handling small works pieces.
16. Never exceed the rated capacity of the machine.

**DO NOT OPERATE THE PR16 POWER ROTARY WITHOUT SAFETY WARNING LABELS AND SHEET METAL COVERINGS GUARDS IN PLACE.**

## SAFETY LABELS

# WARNING

## TO PREVENT SERIOUS BODILY INJURY

- Know the safety and operating instructions for this machine as outlined in the operations manual
- Be certain this machine is properly wired and grounded to conform with the National Electric Code
- Wear safety glasses or eye protection devices
- Do not wear loose clothing, rings, or jewelry while operating the machine
- Never adjust the machine with power on
- Keep hands clear of rolls when operating
- Use work holding devices such as tongs for handling small works pieces
- Never leave machine running unattended
- Do not operate machine with guards or safety cable removed
- Disconnect machine from power source before attempting maintenance or repairs
- Keep work area clear and in proper order
- Do not exceed the capacity of this machine
- Do not remove this sign from machine

## WARNING

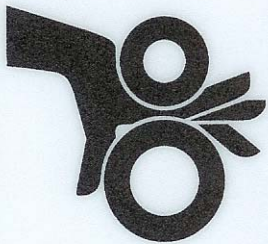

**CRUSH HAZARD**  
Keep hands clear  
of rolls during  
operation.

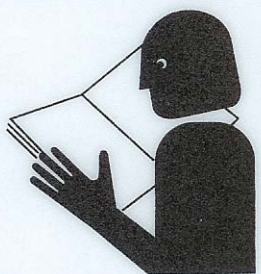

Read instruction  
and safety  
information  
prior to start-up.

## DANGER



**HIGH VOLTAGE**  
Turn off, lockout/  
tag out main power  
disconnect before  
servicing.



## RECEIVING THE MACHINE

1. Any damage that may have occurred during shipping must be reported immediately.
2. Use caution in transporting the machine within your facility. The machine is top heavy.
3. Strap through the two lifting rings located on the top of the main housing of the machine and lift the machine off of the shipping pallet. Note\* the machine has an approximate shipping weight of 350 lbs. be sure that your lifting mechanisms can handle that load.
4. After the machine has been removed from the shipping pallet, it should be leveled and bolted to the floor using ½ inch lagging bolts.
5. A qualified electrician should be used to connect the machine to the main electrical supply; all cables have been prepared so that only the main supply line is all that needs to be connected to the terminals inside the electrical box. Please consult Tennsmith if any questions arise during electrical installation.

## OPERATION SAFETY

1. **Warning!** Due to the nature of the machine and the necessity to feed parts by hand into the machine while it is turning, great care must be followed to ensure that fingers, hands, and body parts do not come near the forming rolls when in use.
2. **Warning!** There is also a danger to fingers and hands while the upper shaft is being set to the proper forming pressure. The upper shaft will move downward towards the lower shaft. Care must be taken to ensure that hands, fingers, and body parts are clear of the two shafts while forming pressure is being set.
3. Protective clothing such as hairnets, tight clothing, and tight fitting protective gloves should be used while operating this machine.
4. Prior to any work being formed, each operator must be thoroughly instructed as to the proper way to handle and guide the work pieces in a safe manner so that the necessary safety clearances between the operator and the machine is met.



**MODEL PR16 PART'S VIEW**

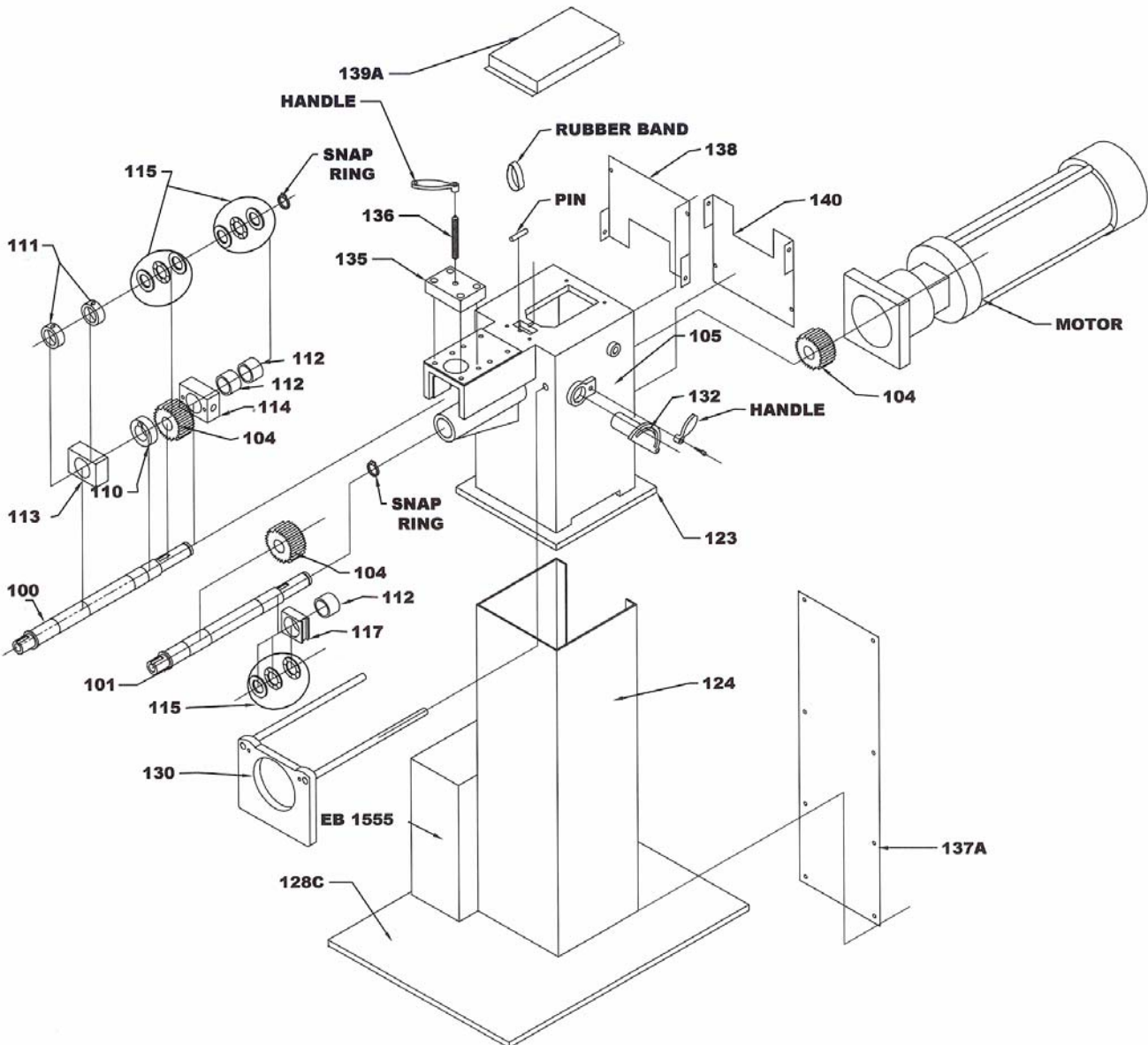

## MODEL PR16 PARTS BREAKDOWN

<u>Part Number</u>	<u>Description</u>	<u>Number Required</u>
100	Top Arbor Shaft	1
101	Bottom Arbor Shaft	1
104	Gear	2
105	Housing	1
110	Tension Ring	1
111	Top Arbor Bushing	2
112	Arbor Bearing	2
113	Front Arbor Block	1
114	Rear Arbor Block	1
115	Thrust Bearing	9
117	Bottom Arbor Adjusting Block	1
120	Top Arbor Adjusting Housing	1
123	Housing Sub Plate	1
124	Stand	1
125	Stand Sub Plate	1
127	Snap Ring	2
130	Material Guide	1
132	Bottom Arbor Adjustment Handle	1
137	Rear Cover Plate	1
138	Top Housing Cover	1
139	Tension Cover	1
140	Bottom Housing Cover	1

## OPERATION of the MODEL PR16

1. The upper arbor (100) of the PR16 is depth controlled either by either by a crank handle located on the top the main cast body of the machine or by hydraulic powered depth selection, depending on which model you have.
2. The lower arbor (101) has in and out horizontal adjustment that is controlled by the lever handle designated part #132 in this manual.
3. An adjustable material guide part #130 is provided to serve as a stop to guide your against while operating this machine.
4. The rolls are secured to the end of the shaft via a small circular plate located on the end of each shaft. An allen wrench is needed to lock and unlock the plate. Be sure that the power is in the off position when adjusting or replacing the rolls. Also, be sure that the rolls are properly seated against the shaft and secured with the circular plate before resuming operation of the machine.
5. **Hydraulic Depth Selection Equipped Machines Only!** The pressure adjustment knob (figure 1) is used to set the pressure rating of the hydraulic clamp tension. The range of the hydraulic pressure is 0 to 2700 psi. The amount of pressure needed will vary depending upon the material type and thickness, and upon the profile or rolls being used. The hydraulic pressure will show a 0 reading on the indicator dial until the top roll engages the material or lower roll. Please consult the factory if you have any questions regarding the pressure adjustment. The Hydraulic depth selection machines are also equipped with a depth selection switch (figure 2) that allows you to jog the upper shaft up or down to engage or disengage the work piece. The proper depth is determined by material type and thickness being formed. It is advised to use a scrap piece of the material being formed to determine the proper depth selection prior to beginning a production run. The machine is also equipped with a directional selector switch that determines the rotation of the rolls. The switch is located on the front of the electrical box facing the operator. The 3 positions on the switch are; 1. Forward 2. Off 3. Reverse. Forward and reverse are engaged by the foot switch (figure 3) provided with the machine. The 2. position (off) allows the operation to engage the depth selection and adjust the hydraulic pressure of the machine without the possibility of the rolls being engaged by the footswitch. **VERIFY THAT THE DIRECTIONAL SELECTOR SWITCH IS IN THE OFF POSITION WHILE SETTING THE UPPER SHAFT DEPTH WITH THE DEPTH SELECTOR SWITCH.**

6. The standard machines have a hand crank adjustment knob located at the top front of the housing (105) of the machine. The adjustment knob controls the depth either up or down, of the upper shaft.
7. Each machine is equipped with a lower roll adjustment handle (part 132). This adjustment allows for the horizontal adjustment of the lower arbor (101) either towards or away from the operator. This movement is determined by rolls be used and profile that you are trying to achieve. Figure 4 shows the roll adjustment handle in detail. The adjustment includes a locking handle that locks and unlocks the lower roll position. To move the lower roll unlock the adjusting handle and move the knob under the handle either up or down depending upon the desired position of the lower roll. If you have any questions regarding this adjustment, please consult the factory.
8. The Material Guide Part (130) is used to serve as a stop for the end of the material to run against as it is being formed. The guide can be moved either in or out as needed to confirm the profile being formed. Figure 5 shows the locking screw that locks and unlocks the material guide.

### **MAINTENANCE AND LUBRICATION**

1. **Warning!** The power must always be disconnected prior to any scheduled maintenance of this machine. Turn the power off at the main disconnect and secure with a safety lock. Service, maintenance and repair should only be carried out by authorized personnel.
2. Models with the hydraulic depth selection option require a 2-quart capacity oil reserve located on underneath the main housing. Check the tank monthly to verify that the oil level is at the lower edge of the filler opening. The oil used at the factory is a T46 Shell Oil hydraulic fluid. Please contact the factory if you have any questions regarding types and quantity of oil needed for your unit. The picture on the following page shows the location of the filler opening under the main housing.
3. We recommend that the hydraulic oil be changed once annually. The drain plug located between the hydraulic motor and the reserve tank. Please consult the factory if you have any questions regarding this procedure.
4. Industrial grade grease should be applied monthly to the drive gears (part #104). Again, power must be disconnected before maintenance of this machine. The figure on the following page shows the top cover (part # 139) removed to show the access to the drive gears (104).

5. A light film of industrial grade lubricant oil should be applied monthly to all exposed metal working parts such as the drive shafts (100 & 101). Clean the area of all excess oil before operating the machine.

**6. Replace all covers and protective devices before operating the machine.**

**PLEASE CONSULT THE FACTORY AT 931-934-2211 IF YOU HAVE ANY QUESTIONS REGARDING THE SAFETY, OPERATION OR MAINTENANCE OF THIS MACHINE.**

**Available Rolls for the Model PR16 Power Rotary**

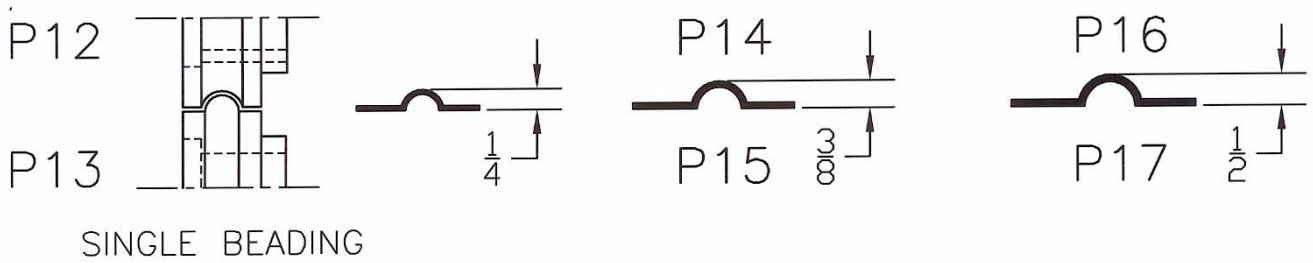
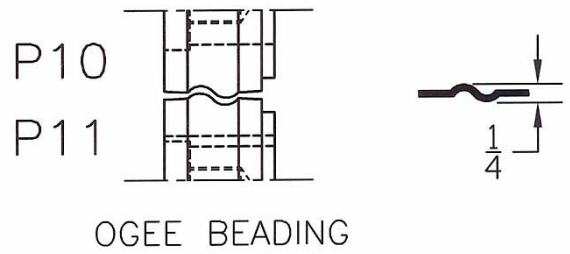
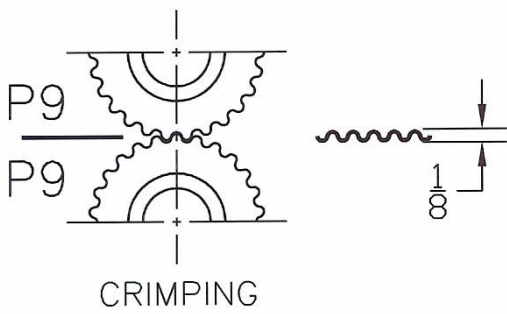
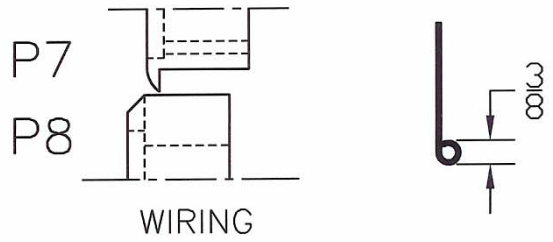
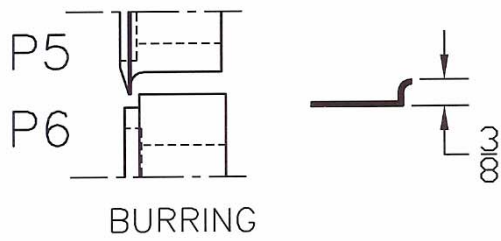
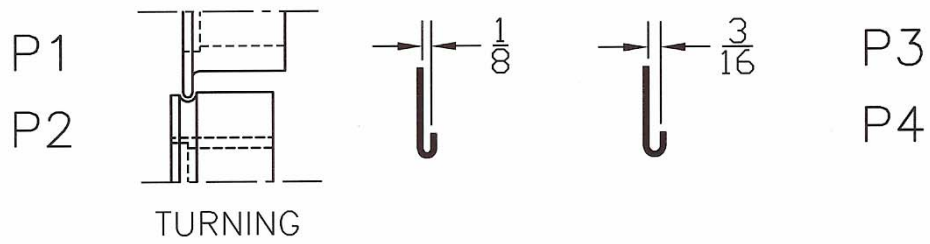

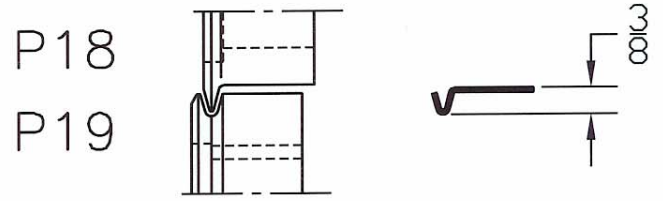

ELBOW EDGING

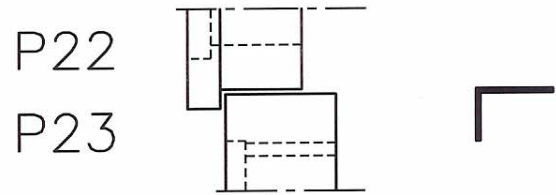
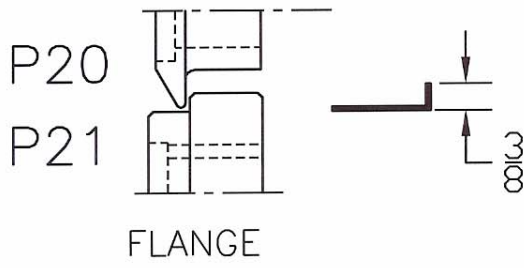

FLATTENING

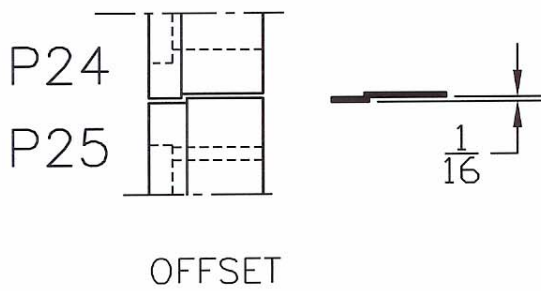

**Additional Rolls are Available. For Custom Applications Please Contact Tennsmith Inc.**