

Instruction Manual

Flow 2go™

The flexible system for mobile thermal drilling on site and in the workshop



Distributed by: **Trick-Tools.com**

Trick-Tools
80 Truman Road
Pella, IA 50219

Phone:1-877-VAN-SANT
E-mail: sales@trick-tools.com



Here at Trick Tools we believe that our customers deserve the best value in their tool and equipment purchases. We are constantly at work searching out a variety of high quality, high performance tools to offer at the best prices possible. Our commitment to you is that we will not offer “cheap junk” anywhere on our website. You, the customer, help us to evaluate our products constantly and as soon as an ongoing quality issue is uncovered we will correct it or discontinue that product immediately. We hope to earn your continued trust.

Table of Contents	Page
1. Conventional use	2
2. General safety and hazard precautions	3
3. Additional safety precautions	3
4. Preparation	4
4.1. Mounting the handles on the drill stand	4
4.2. Mounting the tool holder	4
5. Use and general application	5
5.1. Connection and commissioning	Error! Bookmark not defined.
5.2. Mounting the drill on the drill stand	5
5.3. Deactivating the hammer function.....	5
5.4. Inserting the collet.....	6
5.5. Inserting the FLOWDRILL® tools	6
5.6. Mains connection	6
5.7. Selecting the speed step and presetting the rotational speed.....	7
5.8. Selecting the rotation direction.....	7
5.9. Positioning the workpiece	7
5.10. Switching the motor on/off	8
5.11. The thermal drilling process.....	8
5.12. Machining time and drilling intervals	8
5.13. Flowtapping with Flowtap.....	9
6. Maintenance	10
6.1. Flowdrill.....	10
6.2. Flowtap	10
6.3. Tool holder and collet.....	10
6.4. Guide system.....	11
6.5. Conversion for left hand operation	11
6.6. Switches and cables	11
7. Trouble shooting	12
8. Range and supply of accessories	13
9. Exploded diagram of the drill stand and names	14
10. Guarantee provisions.....	15

1. Conventional use

The *mobile thermal drilling unit* (from here on known as *Flow2go*) includes the enclosed hand drill, stand and tool holder, which is suitable for conventional drilling as well as thermal drilling in thin walled material. The maximum wall thickness for this unit is dependant on the diameter of the hole and thickness of material; the following table shows the maximum wall thickness for the respective thread sizes. The Flow2go unit contains only FLOWDRILL® thermal drilling tools of the “Long” type.

Thread	Flowdrill Ø [mm]	Material thickness max. [mm]
M4	3.7	2.5
M5	4.5	
M6	5.4	
M8	7.3	



NOTE

The Flow2go unit is not a replacement for a column-type drilling machine and is not suitable for long-term or series production in association with thermal drilling!

A maximum of 4 thermal drilled holes per minute may be made.

We recommend that the operation of the drill is then turned off for 2 minutes.

The user bears sole responsibility for damages due to incorrect use.

This includes in particular:

- ▶ The use of Flowdrill designs other than the specified “Long” type.
- ▶ The use of Flowdrill tools larger than specified.
- ▶ Thermal drilling in materials thicker than permitted for the tool type.
- ▶ Thermal drilling at an angle, i.e. not vertical to the component surface.
- ▶ Thermal drilling other than from the highest point on a round tube.
- ▶ Thermal drilling in materials that do not fall under the category “metals”.
- ▶ Thermal drilling with set active hammer drilling stage (if technically possible).
- ▶ The use of unsuitable lubricants.
- ▶ The use of Flowdrill tools in the normal three-jaw chuck.
- ▶ The execution of thermal drilling work with hand drill units not corresponding to the following types: Metabo BE 1020 and Metabo SBE 1010 Plus.
- ▶ The use of low-performance drills.
- ▶ Using the Flowtap without suitable lubricant.

Generally accepted accident prevention regulations as well as all the enclosed and listed safety precautions must be complied with.

2. General safety and hazard precautions

Before using the hand drill read the enclosed safety precautions (red volume) as well as the instruction manual carefully and completely. Keep all the enclosed documents and only pass on the Flow2go unit together with these documents.



Read instruction manual



Warning of hazardous electric voltage



Use eye protection



Warning of hot surface



Wear protective gloves



Do not expose to rain



Wear suitable work clothing

3. Additional safety precautions

- ▶ Please read the instructions for use before starting to work with the machine.
- ▶ The hand drill unit supplied is only suitable for thermal drilling in conjunction with the drill base and the customised tool holder.
- ▶ To avoid eye injury, please wear protective goggles.
- ▶ Before any adjustment, maintenance or repair the mains plug must be unplugged.
- ▶ The tool and drill chuck are very hot after use. Please wear gloves to change the tool or allow it to cool down completely.
- ▶ Functions and operation of the electronic control module of the drill:
 1. Protection of operators from accidents.
 2. Ensure a long life for the drill and the tools.
 3. Rotational speed setting and automatic regulation according to the relevant technological requirements.
- ▶ Please refer to the enclosed pink Metabo "Safety Precautions" brochure for further information.

4. Preparation

For the proper functioning of the Flow2go unit when thermal drilling and for industrial safety reasons, the following must be taken into account:

4.1. Mounting the handles on the drill base

Please screw the 3 handles enclosed fully up to the stop in the openings provided for this purpose on the capstan shaft.

4.2. Mounting the tool holder

Only the enclosed tool holder (see Figure) should be used for thermal drilling. To use it the three-jaw chuck pre-mounted on the drill must first be removed. For this fully unscrew the drill chuck and while holding up the spindle unscrew the inner retaining screw (where present) with a suitable screwdriver to the right (N.B.: left-hand thread!). Please refer to the instructions for using the drill for further information.



Retaining screw with left-hand thread.

The tool holder must be screwed on fully and firmly tightened. Then the tool holder must also be re-secured from inside with the enclosed short retaining screw.

Always use only tools and accessories that are in perfect condition!

The tool shafts must be in perfect condition and free of contaminants. They must not show any signs of damage.

The collet in the tool holder should be carefully checked before using a drill and if necessary cleaned or in case of damage replaced.

Mobile connecting leads should not be stretched under tension. All damage should be avoided as this may cause danger due to the electric current. Do not use the drill if the connecting leads are damaged. First have the equipment repaired by an authorised specialist firm.

5. Use and general application

5.1. Mains power

Please check the mains voltage first. The mains voltage indicated on the hand drill must correspond with the electric mains supply.

5.2. Mounting the drill on the drill stand

1. If necessary loosen clamping nut (socket, hexagonal socket head) of the circular clamp.
2. Insert the hand drill unit vertically into the collar as far as the stop.
3. Now hand tighten the clamping screw.



NOTE

Should the drill be pushed upwards out of the collar during drilling because of the axial force occurring, immediately stop the drilling process and repeat steps 1-3.

Make sure that the surface on which the drill stand is placed is level. If necessary the base plate of the drill stand must be fixed firmly to this surface with suitable screw fasteners

5.3. Deactivating the percussion stage

When using a hammer drill, the hammer function must be deactivated for thermal drilling and flowtapping. Switch the drill over to the normal drill function.

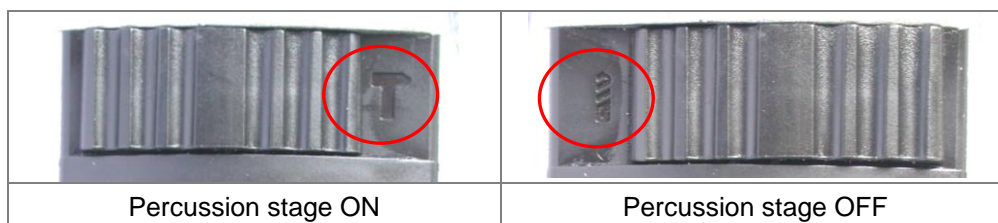

5.4. Inserting the collet

1. Insert the collet at a slight angle into the screwed cap and turn both using light pressure in opposite directions until the collet perceptibly locks and sits vertically in the screwed cap. The collet should no longer fall out on its own.

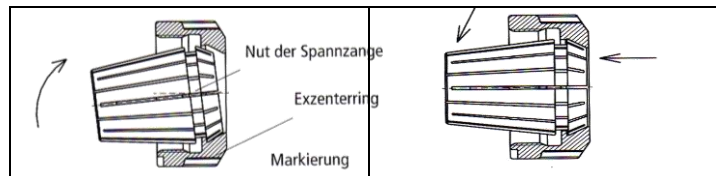

Nut der Spannzange = Groove of collet, Exzenterring = Eccentric ring, Markierung = Marking

2. Now screw both together onto the drill chuck such that the tool shaft can then be inserted with slight suction.

5.5. Inserting the FLOWDRILL® tools

The Flowdrill or Flowtap is inserted with the tool holder already mounted and the screwed cap including collet lightly tightened. All tools must be inserted fully as far as the stop. Then hand tighten the screwed cap. To fully tighten the tools please use the enclosed spanners (spanner SW19 / open-ended spanner SW25).

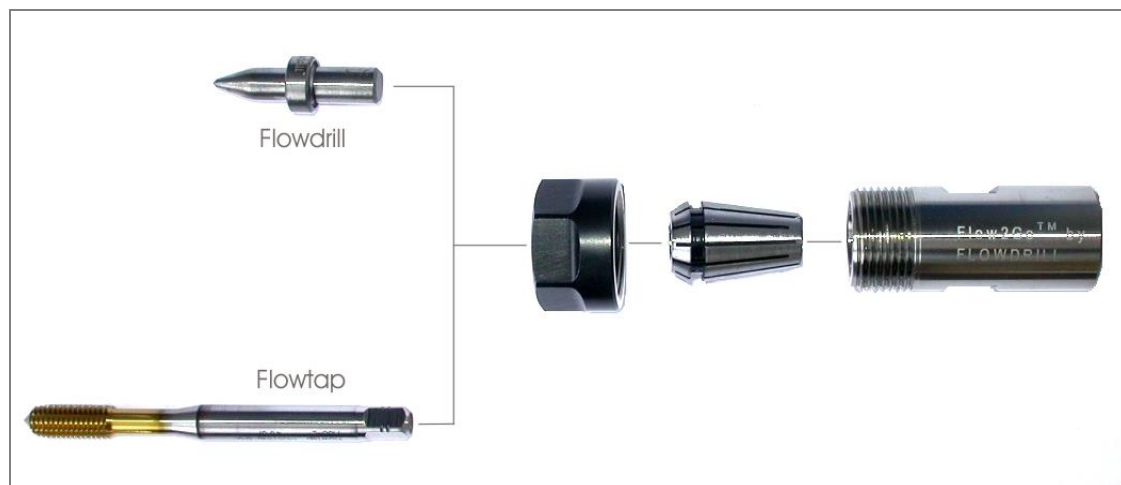

5.6. Mains connection

Connect the mains plug to the mains supply. If you are using an extension cable, ensure that it is designed for the rating of the machine.

5.7. Selecting the speed step and presetting the rotational speed

The speed step of the work spindle should be selected irrespective of the material and drill diameter in accordance with the following Table:

Machine setting				
Thread	Flowdrill Ø [mm]	Material thickness max.*	Rpm Flowdrill	Rpm Flowtap

Maschineneinstellung				
Gewinde	Flowdrill Ø [mm]	Materialstärke max.*	U/min Flowdrill	U/min Flowtap
M4	3.7	2.5 mm	G 2600	A 150
M5	4.5			
M6	5.4			
M8	7.3			

*Werkzeugausführung „lang“

* Tool design “long”

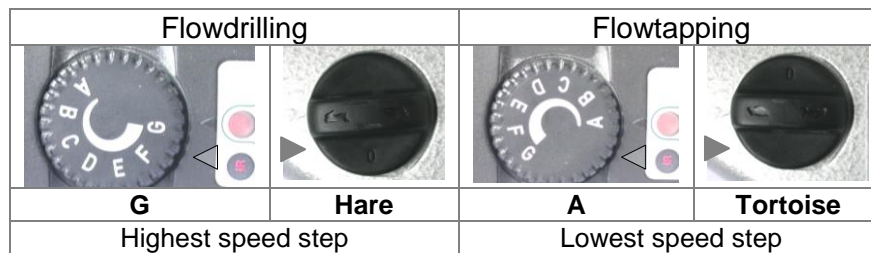

5.8. Selecting the rotation direction

Flowdrilling (FLOWDRILL) and Flowtapping (FLOWTAP): right turn.

For Flowtapping with right turn tapping, holding, and screwing out with left turn.

The presetting switch can only be operated during shutdown.

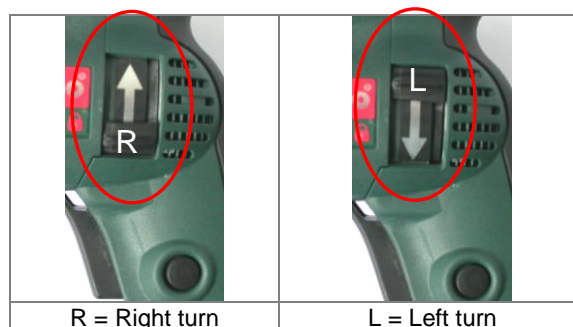

5.9. Positioning the work piece

Please secure the work piece to be machined in the vice firmly, horizontally and free of vibration. Position the work piece such that you only drill between the jaws of the vice, never outside them. Position the vice on the drill stand. In particular make sure that you only drill perpendicularly to the surface. For circular tubes please pay special attention so that you only drill on the uppermost point of the round tube.

5.10. Switching the motor on/off



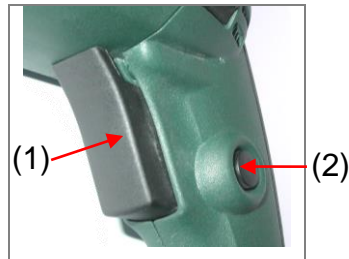

To switch on the motor please press the pushbutton (1) and lock this by pressing in the button on the side (2).



To switch off the motor press the pushbutton again as far as the stop – this automatically unlocks it – and release it again. Wait until the motor has come to a complete standstill.

5.11. The thermal drilling process

Picture sequence from left to right

				
Move drill close to the surface and press down lightly, then constantly increase pressure.	As the resistance eases, continually increase the feed rate.	Do not interrupt the process, but proceed with continually accelerated movement and gradually form the bush.	When forming the collar (bead) reduce the feed slightly. Do not form an excessively flat collar.	After thermal drilling raise the drill again without delay!

Depending on the material type, thermal drilling requires a different force to be exerted (high-grade steel = hard, aluminium = soft). Drill with a continually increasing pressure.

You will recognise too high a pressure

- From a clearly audible reduction in the drill speed. For safety purposes the integrated electronics of the motor automatically turn the hand drill unit off.
- From deformation of the component surface.

In both cases, please reduce the contact pressure immediately. Greater pressure does not speed up drilling, the drill wears out more quickly and the unit is overloaded.

5.12. Machining time and drilling intervals

As a guideline for thermal drilling, a machining time of approx. 5 seconds should be adhered to.

A maximum of 4 thermal drill holes per minute should be made!

We recommend that the operation of the drill is then turned off for 2 minutes.



NOTE

Please ensure that the component surface is dry or when in the drilling position and is free of water/oil and other strong contaminants. Do not use any unauthorised lubricants or releasing agents for thermal drilling on this mobile drill base! Our special releasing agent FDKS is available as an option for thermal drilling.

5.13. Flowtapping with Flowtap

- ▶ Change the tool and replace the Flowdrill with the Flowtap.



NOTE

To hold the optionally available M4 flowtap you require a (further smaller) collet of type ER16Ø4mm that is available as an accessory.

- ▶ Set the required rotational speed (tortoise + A = approx. 150min^{-1}).
- ▶ Position the Flowtap accurately over the drill hole.
- ▶ Position the component and the vice.
- ▶ Lubricate the Flowtap well before each use with FTMZ and press lightly into the material. The Flowtap rotates automatically.
- ▶ Always guide the process when moving in and out by hand. If possible the full operating range of the Flowtap should be used. Take into account here the maximum possible penetration depth.
- ▶ Stop the unit and now change the direction of rotation of the spindle to LEFT TURN and press the pushbutton again. Guide the removal of the Flowtap by hand.

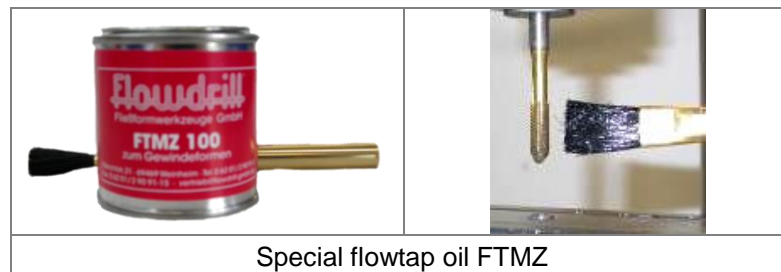

Special flowtap oil FTMZ



TIP 1: To stop the flowtap promptly when inserting do not lock the pushbutton but keep the button pressed with your hand.



TIP 2: Alternatively you can also use the Flowtap in a high-performance battery operated drill and low speed step and insert the Flowtap by guiding it freely.



TIP 3: You will obtain optimum starting values and load capacities with (grease- or oil-free) taps that are then cleaned.

6. Maintenance

6.1. Flowdrill

The friction or contact surfaces of the Flowdrill have the tendency for foreign material to adhere, which in places coats the drill. This adhesion tendency is very material-dependent and cannot be avoided entirely. For this reason clean the Flowdrill regularly with an emery cloth and remove adhesions promptly.



New condition	Tool with adhesions	Cleaning while rotating with emery cloth
		

6.2. Flowtap

The Flowtap should never be used dry, but always in conjunction with special tapping oil (e.g. FTMZ from Flowdrill®). Make sure the tapping flanks are clean and free of dirt and scratches. Clean the Flowtap if necessary with a soft wire brush and/or compressed air.

6.3. Tool holder and collet

Regularly clean the tool holder from inside and remove all contamination in the gaps of the collet.

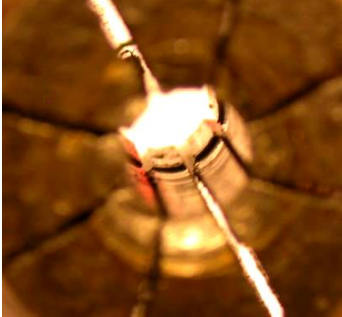
Very dirty collet	Damaged collet	
	a) outside	b) inside
		
clean, if necessary replace	replace	replace

6.4. Guide system

Regularly check the guide system. This must if necessary be lubricated or readjusted. To readjust please loosen the lock nuts (12) and cylindrical head screws (13) of the guide rail (2) and evenly tighten the adjustment screws (11). Then retighten first the cylindrical head screws and then the lock nuts.



Items (2, 11, 12, 13) according to exploded drawing Section 9.

6.5. Conversion for left hand operation

The capstan can be easily converted for left hand operation. To do this raise the guides to the upper stop and then loosen the cross-head screw (7) and remove this together with the washer (18). Completely remove the shaft (6) from the capstan and mount this in the reverse order from the left. *Items (6, 7, 18) according to exploded drawing Section 9.*

6.6. Switches and cables

Regularly check switches, cables and anti-kink protection for damage.



NOTE

The cable must not come into contact with the hot component or tool surface!
Repairs should only be carried out by an authorised specialist firm.

The tool life depends among other things on:

- Process time
- Material thickness
- Material type (e.g. steel versus stainless steel)
- Care and maintenance
- Condition of the accessories: in particular tool holder and collet

7. Trouble shooting

Problem	Cause	Remedy
Motor does not start	<ul style="list-style-type: none"> - No mains voltage - Rotation direction not selected - Switch not clearly positioned - Switch or lead faulty - Carbon brushes worn (observe flashing light!) 	<ul style="list-style-type: none"> - Check mains voltage - Preset rotation direction - Have switch or lead replaced - Have carbon brushes replaced
Motor running, but the spindle does not rotate	<ul style="list-style-type: none"> - Switch is not clearly positioned 	<ul style="list-style-type: none"> - Check and correctly set switch position
Motor stops when drilling	<ul style="list-style-type: none"> - Contact pressure too high - Electronics switch off automatically 	<ul style="list-style-type: none"> - Reduce contact pressure - Wait a short time, then start again
Drilling not possible in spite of correctly set rotational speed	<ul style="list-style-type: none"> - Tool also rotates in the collet - Material thicker than permitted 	<ul style="list-style-type: none"> - Re-clip tool - Replace collet - Use thinner material
Workpiece and/or vice is raised when flowtapping	<ul style="list-style-type: none"> - Workpiece clamping not sufficient - Vice not secured 	<ul style="list-style-type: none"> - Re-clip workpiece - Secure vice
Flowtap gets stuck	<ul style="list-style-type: none"> - Thermal drill hole not completely tapped (material too thick) - Bush/bush length too conical - Lack of lubrication 	<ul style="list-style-type: none"> - Fully tap bush - Manually unscrew tool - Use thinner material - Lubricate tool
Tool holder rotates with left turn of the spindle	<ul style="list-style-type: none"> - Retaining screw missing or is not firmly tightened 	<ul style="list-style-type: none"> - Tighten or reorder retaining screw
Drill is pushed upwards out of the clamp during drilling	<ul style="list-style-type: none"> - Clamping screw not tightened 	<ul style="list-style-type: none"> - Tighten clamping screw
The feed is very difficult to access without drilling	<ul style="list-style-type: none"> - Foreign bodies between the guides - The pre-tensioning of the guide is too high 	<ul style="list-style-type: none"> - Remove contaminants (dirt, chips etc.) - Re-adjust the guide system in accordance with maintenance instructions
The slide moves downwards on its own due to its own weight	<ul style="list-style-type: none"> - The pre-tensioning of the guide is too low 	<ul style="list-style-type: none"> - Re-adjust the guide system in accordance with maintenance instructions

8. Range and supply of accessories

This “Flow2go unit” as delivered consists of the following items:

No.	Article name	Description	Consumable	Quantity
1.	Drill base	“Flow2Go“ drill base	--	1
2.	Vice	Machine vice	--	1
3.	Lock screw	T-slot lock screw including washer and nut	--	2
4.	Metabo	Metabo hand drill unit with 3-jaw tool holder	--	1
5.	Screw	Retaining screw left-hand thread for drill chuck	--	1
6.	Tool holder	Customized tool holder for ER16 including clamp nut	--	1
7.	426E06	Collet Ø 6mm	Yes	1
8.	426E08	Collet Ø 8mm	Yes	1
9.	Spanner SW19	Spanner SW19	--	1
10.	Open-ended spanner SW25	Open-ended spanner SW25 for clamp nut	--	1
11.	05.4L000	Flowdrill 5.4 Long for M6	Yes	1
12.	M06TINS	Flowtap M6x1 - TIN coating - lubrication groove	Yes	1
13.	07.3L000	Flowdrill 7.3 Long for M8	Yes	1
14.	M08TINS	Flowtap M8x1.25 – TIN coating – lubrication groove	Yes	1
15.	FTMZ 100	Tapping oil 100ml	Yes	1
16.	Bristle brush	Bristle brush	Yes	1
17.	Socket spanner	Hexagonal head socket spanner SW5	--	1
18.	Box	Tool and accessories box	--	1
19.	Packaging	Dispatch packaging	Non-returnable	1

As replacement or in addition the following optional items are available:

No.	Article name	Description	Consumable
1.	03.7L000	Flowdrill 3.7 Long for M4	Yes
2.	04.5L000	Flowdrill 4.5 Long for M5	Yes
3.	05.4L000	Flowdrill 5.4 Long for M6	Yes
4.	07.3L000	Flowdrill 7.3 Long for M8	Yes
5.	M04TINS	Flowtap M4x0.7 - TIN Coating - lubrication groove	Yes
6.	M05TINS	Flowtap M5x0.8 - TIN Coating - lubrication groove	Yes
7.	M06TINS	Flowtap M6x1 - TIN Coating - lubrication groove	Yes
8.	M08TINS	Flowtap M8x1.25 - TIN Coating - lubrication groove	Yes
9.	426E04	Collet Ø 4mm for Flowtap M4*	Yes
10.	426E06	Collet Ø 6mm	Yes
11.	426E08	Collet Ø 8mm	Yes
12.	FTMZ 100	Tapping oil 100ml	Yes
13.	Bristle brush	Bristle brush	Yes
14.	FDKS100	Releasing agent paste 100g for thermal drilling made of steel, high-grade steel, copper and aluminium	Yes
15.	Brass brush	Brass brush for FDKS	Yes

9. Exploded diagram of the drill base and names

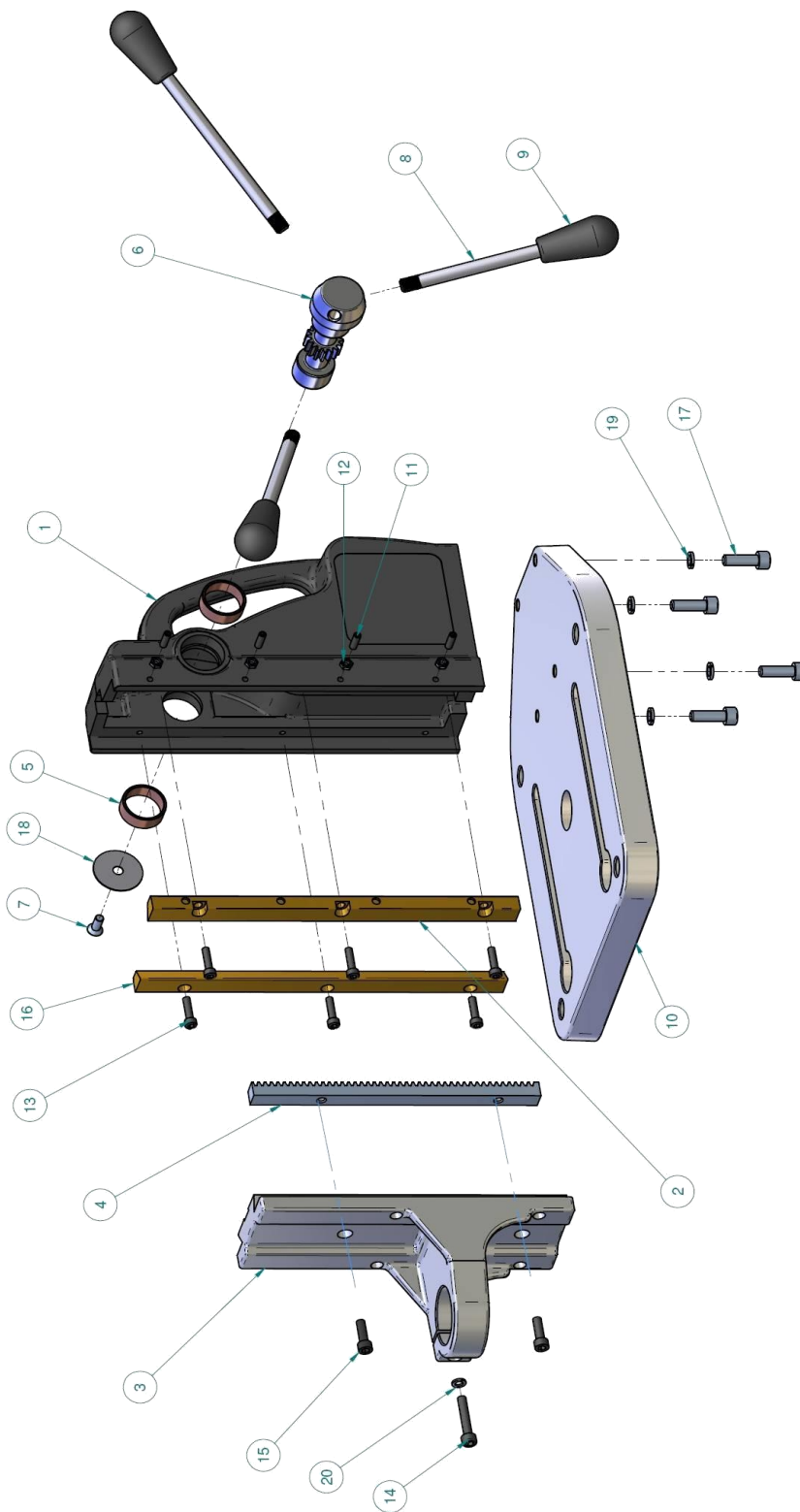

Item No.	Name	Qty
1.	Housing	1
2.	Adjustment guide rail	1
3.	Guide	1
4.	Gear rack	1
5.	Slide bearing	2
6.	Gear rack shaft	1
7.	Lens lowering screw	1
8.	Handle rod	3
9.	Snap-on handle	3
10.	Base plate	1
11.	Re-adjustment screw	4
12.	Nut	4
13.	Cylindrical head screw	6
14.	Cylindrical head screw	1
15.	Cylindrical head screw	2
16.	Guide rail	1
17.	Cylindrical head screw	4
18.	Washer	1
19.	Spring washer	4
20.	Spring washer	1
	Total weight:	6.3 kg



10. Guarantee provisions

For the hand drill unit hereby purchased the manufacturer's guarantee provisions apply in conjunction with the information listed in this instruction manual.

Damage due to natural wear and tear, overloading or unauthorised handling of the unit, tools or drill base, are excluded from the guarantee.

Damage arising due to material or manufacturing faults is rectified free of charge by delivery of a replacement or repair. Objections can only be acknowledged if the equipment/system is sent undismantled and carriage-free to Flowdrill or to the authorised contractual partner.

No claims for compensation may be derived from this guarantee statement.

Please fill in the guarantee certificate including all the following details and enclose the original evidence of purchase (*Delivery note/invoice*).

.....
Machine type: _____

Machine number: _____

Date of sale: _____

Stamp/Date/Signature of the Dealer:

.....
Description of fault:

