

evOLUTION®

EVO180

180mm (7") TCT STEEL CIRCULAR SAW

Instruction Manual

Read instructions before operating this tool.



GB

Original Instructions

Read instructions before operating this tool.



EVO 180mm Steel Cutting Circular Saw

TABLE OF CONTENTS

EC - Declaration of Conformity	03
Important Information	03
12 Month Limited Warranty	03
General Safety Rules	04
Safety Instructions for All Saws.....	05
Symbols & Labels	06
Additional Specific Safety Rules....	07
Specification	07
Assembly	08
Machine Overview	09
Getting Started	10
Maintenance	13
Environmental Protection	14
Service Parts Diagram.....	15



EC - DECLARATION OF CONFORMITY

GB

We, manufacturer and importer

Evolution Power Tools Ltd.
Venture One
Sheffield
S20 3FR

Declare that the product

Part numbers:
Evolution: STEEL
Circular Saw 180mm

Complies with the essential requirements of the following European Directives:

2006/42/EC – Machine Directive
2006/95/EC – Low Voltage Directive
2004/108/EC – EMC Directive
2002/95/EC – Restriction of the use of Certain Hazardous Substances in Electrical and Electric Equipment

Standards and Technical specifications referred to:-

EN55014-1 : 2006
EN55014-2 : 1997+A1
EN61000-3-2 : 2006
EN61000-3-3 : 1995+A1+A2
EN60745-1 : 2003+A1
EN60745-2-5 : 2003
EN60825-1 : 1994+A1+A2

All documentation is held on file at the above address and is available, on request for review.

Authorised Signatory

Name: Mr Matthew J Gavins

Position: Managing Director

Date: 1st June 2011

IMPORTANT INFORMATION

GB

Please read these operating and safety instructions carefully and completely. For your own safety, before using this equipment check that the voltage is correct and that all handles and parts are firmly secured. If you are uncertain about any aspect of using this equipment, please contact our Technical Help Resource.

Technical Helpline UK

0870 609 2297

EVO 180MM STEEL CUTTING CIRCULAR SAW

Congratulations on your purchase of an Evolution Power Tools machine. Please complete your product registration on line to validate your machine's warranty period and ensure prompt service if needed. We sincerely thank you for selecting a product from Evolution Power Tools.

12 MONTH LIMITED WARRANTY

GB

Evolution power tools reserves the right to make improvements and modifications to design without prior notice.

Evolution Power Tools will, within twelve (12) months from the original date of purchase, repair or replace any goods found to be defective in materials or workmanship. This warranty is void if the tool being returned has been used to cut materials beyond the recommendations in the Instruction Manual or if the saw has been damaged by accident, neglect, or improper service. This warranty does not apply to machines and/or components which have been altered, changed, or modified in any way, or subjected to use beyond recommended capacities and specifications. Electrical components are subject to respective manufacturers' warranties. All goods returned defective shall be returned prepaid freight to Evolution Power Tools. Evolution Power Tools reserves the right to optionally repair or replace it with the same or equivalent item. There is no warranty – written or verbal – for saw blades. In no event shall Evolution Power Tools be liable for loss or damage resulting directly or indirectly from the use of our merchandise or from any other cause. Evolution Power Tools is not liable for any costs incurred on such goods or consequential damages.

No officer, employee or agent of Evolution Power Tools is authorised to make oral representations of fitness or to waive any of the foregoing terms of sale and none shall be binding on Evolution Power Tools. Questions relating to this limited warranty should be directed to the company's head office, or call the appropriate Helpline number.

IMPORTANT SAFETY INSTRUCTIONS

GB

To reduce the risk of electric shock, this equipment is fitted with an approved cord and plug for its intended country of use. Do not change the cord or plug in any way.

GENERAL SAFETY RULES

GB

Read and understand all instructions before operating this product. Failure to follow all instructions listed below, may result in electric shock, fire and / or serious personal injury. **Save These Instructions For Future Reference.**

Read all these instructions before attempting to operate this product and save these instructions.

The term "power tool" in the warnings refers to your mains-operated (corded) power tool or battery-operated (cordless) power tool.

SAFETY INSTRUCTIONS FOR CIRCULAR SAWS

GB

WARNING: Read all instructions. Failure to follow all instructions listed below may result in electric shock, fire and/or serious injury.

Please save these instructions.

1) Work Area Safety

- a) Keep work area clean and well lit. Cluttered or dark areas invite accidents.**
- b) Do not operate power tools in explosive atmospheres, such as in the presence of flammable liquids, gases or dust.** Power tools create sparks which may ignite the dust or fumes.
- c) Keep children and bystanders away while operating a power tool.** Distractions can cause you to lose control.

2) Electrical Safety**a) Power tool plugs must match the outlet.**

Never modify the plug in any way. Do not use any adapter plugs with earthed (grounded) power tools. Unmodified plugs and matching outlets will reduce risk of electric shock.

b) Avoid body contact with earthed or grounded surfaces, such as pipes, radiators, ranges and refrigerators. There is an increased risk of electric shock if your body is earthed or grounded.

c) Do not expose power tools to rain or wet conditions. Water entering a power tool will increase the risk of electric shock.

d) Do not abuse the cord. Never use the cord for carrying, pulling or unplugging the power tool. Keep cord away from heat, oil, sharp edges or moving parts. Damaged or entangled cords increase the risk of electric shock.

e) When operating a power tool outdoors, use an extension cord suitable for outdoor use. Use of a cord suitable for outdoor use reduces the risk of electric shock.

f) If operating a power tool in a damp location is unavoidable, use a residual current device (RCD) protected supply. Use of an RCD reduces the risk of electric shock.

3) Personal Safety

a) Stay alert, watch what you are doing and use common sense when operating a power tool. Do not use a power tool while you are tired or under the influence of drugs, alcohol or medication. A moment of inattention while operating power tools may result in serious personal injury.

b) Use personal protective equipment. Always wear eye protection. Protective equipment such as dust mask, non-skid safety shoes, hard hat, or hearing protection used for appropriate conditions will reduce personal injuries.

c) Prevent unintentional starting. Ensure the switch is in the off-position before connecting to power source and/or battery pack, picking up or carrying the tool. Carrying power tools with your finger on the switch or energising power tools that have the switch on invites accidents.

d) Remove any adjusting key or wrench before turning the power tool on. A wrench or a key left attached to a rotating part of the power tool may result in personal injury.

e) Do not overreach. Keep proper footing and balance at all times. This enables better control of the power tool in unexpected situations.

f) Dress properly. Do not wear loose clothing or jewellery. Keep your hair, clothing and gloves away from moving parts. Loose clothes, jewellery

or long hair can be caught in moving parts.

g) If devices are provided for the connection of dust extraction and collection facilities, ensure these are connected and properly used. Use of dust collection can reduce dust-related hazards.

4) Power Tool Use & Care

a) Do not force the power tool. Use the correct power tool for your application. The correct power tool will do the job better and safer at the rate for which it was designed.

b) Do not use the power tool if the switch does not turn it on and off. Any power tool that cannot be controlled with the switch is dangerous and must be repaired.

c) Disconnect the plug from the power source and/or the battery pack from the power tool before making any adjustments, changing accessories, or storing power tools. Such preventive safety measures reduce the risk of starting the power tool accidentally.

d) Store idle power tools out of the reach of children and do not allow persons unfamiliar with the power tool or these instructions to operate the power tool. Power tools are dangerous in the hands of untrained users.

e) Maintain power tools. Check for misalignment or binding of moving parts, breakage of parts and any other condition that may affect the power tool's operation. If damaged, have the power tool repaired before use. Many accidents are caused by poorly maintained power tools.

f) Keep cutting tools sharp and clean. Properly maintained cutting tools with sharp cutting edges are less likely to bind and are easier to control.

g) Use the power tool, accessories and tool bits etc. in accordance with these instructions, taking into account the working conditions and the work to be performed. Use of the power tool for operations different from those intended could result in a hazardous situation.

5) Service

Have your power tool serviced by a qualified repair person using only genuine replacement parts. This will ensure that the safety of the power tool is properly maintained.

6) Safety Instructions for all Saws

a) DANGER: Keep hands away from cutting area and the blade. Keep your second hand on auxiliary handle, or motor housing. If both hands are holding the saw, they cannot be cut by the blade.

b) Do not reach underneath the workpiece. The guard cannot protect you from the blade below the

workpiece.

c) Adjust the cutting depth to the thickness of the workpiece. Less than a full tooth of the blade teeth should be visible below the workpiece.

d) Never hold piece being cut in your hands or across your leg. Secure the workpiece to a stable platform. It is important to support the work properly to minimize body exposure, blade binding, or loss of control.

e) Hold power tool by insulated gripping surfaces when performing an operation where the cutting tool may contact hidden wiring or its own cord. Contact with a "live" wire will also make exposed metal parts of the power tool "live" and shock the operator.

f) When ripping always use a rip fence or straight edge guide. This improves the accuracy of cut and reduces the chance of blade binding.

g) Always use blades with correct size and shape (diamond versus round) of arbor holes. Blades that do not match the mounting hardware of the saw will run eccentrically, causing loss of control.

h) Never use damaged or incorrect blade washers or bolt. The blade washers and bolt were specially designed for your saw, for optimum performance and safety of operation.

ADDITIONAL SAFETY INSTRUCTIONS

GB

Causes and operator prevention of kickback:

Kickback is a sudden reaction to a pinched, bound or misaligned saw blade, causing an uncontrolled saw to lift up and out of the workpiece toward the operator:

1. When the blade is pinched or bound tightly by the kerf closing down, the blade stalls and the motor reaction drives the unit rapidly back toward the operator;
2. If the blade becomes twisted or misaligned in the cut, the teeth at the back edge of the blade can dig into the top surface of the workpiece causing the blade to climb out of the kerf and jump back towards the operator.

Kickback is the result of saw misuse and/or incorrect operating procedures or conditions and can be avoided by taking proper precautions as given below.

a) Maintain a firm grip with both hands on the saw and position your arms to resist kickback forces. Position your body to either side of the blade, but not in line with the blade. Kickback could cause the saw to jump backwards, but kickback

forces can be controlled by the operator, if proper precautions are taken.

b) If the blades are binding, or when interrupting a cut for any reason, release the trigger and hold the saw motionless in the material until the blades come to a complete stop. Never attempt to remove the saw from the work or pull the saw backward while the blades are in motion or kickback may occur. Investigate and take corrective actions to eliminate the cause of blade binding.

c) When restarting a saw in the workpiece, centre the saw blade in the kerf and check that saw teeth are not engaged into the material. If saw blade is binding, it may walk up or kickback from the workpiece as the saw is restarted.

d) Support large panels to minimise the risk of blade pinching and kickback. Large panels tend to sag under their own weight. Supports must be placed under the panel on both sides, near the line of cut and near the edge of the panel.

e) Blade depth and bevel adjusting locking levers must be tight and secure before making a cut. If the blade adjustment shifts while cutting it may cause binding and kickback.

f) Do not use dull or damaged blades. Unsharpened or improperly set blades produce a narrow kerf causing excessive friction, blade binding and kickback.

g) Use extra caution when making a “plunge cut” into existing walls or other blind areas. The protruding blade may cut objects that can cause kickback.

h) Check lower guard for proper closing before each use. Do not operate the saw if lower guard does not move freely and close instantly. Never clamp or tie the lower guard into the open position. If saw is accidentally dropped, lower guard may be bent. Raise the lower guard with the retracting handle and make sure it moves freely and does not touch the blade or any other part, in all angles and depths of cut.

i) Check the operation of the lower guard spring. If the guard and the spring are not operating properly, they must be serviced before use. Lower guard may operate sluggishly due to damaged parts, gummy deposits, or a build-up of debris.

j) Lower guard may be retracted manually only for special cuts such as “plunge cuts” and “compound cuts.” Raise lower guard by retracting handle and as soon as blade enters the material, the lower guard must be released. For all other sawing, the lower guard should operate automatically.

k) Always observe that the lower guard is covering the blade before placing saw down on a bench or the floor. An unprotected, coasting

blade will cause the saw to walk backwards, cutting whatever is in its path. Be aware of the time it takes for the blade to stop after switch is released.

HEALTH ADVICE





WARNING: When drilling, sanding, sawing or grinding, dust particles will be produced. In some instances, depending on the materials you are working with, this dust can be particularly harmful to you (e.g. lead from old gloss paint). You are advised to consider the risks associated with the materials you are working with and to reduce the risk of exposure.

You should:

- Work in a well-ventilated area.
- Work with approved safety equipment, such as dust masks that are specially designed to filter microscopic particles.

SYMBOLS AND LABELS GB

WARNING: Do not operate machine if warning and / or instruction labels are missing or damaged. Contact Evolution Power Tools for replacement labels.

Symbol	Description
V	Volts
A	Amperes
Hz	Hertz
min	Minutes
~	Alternating current
no	no load speed
	Double Insulated
	Read Instructions
	Wear eye Protection
	Wear ear protection
	Wear dust mask

Only use genuine Evolution replacement parts. Unauthorized parts may be **dangerous!**

To obtain an additional copy of your manual, please contact Evolution Power Tools at:

UK 0870 609 2297
WEB www.evolutionpowertools.com

ADDITIONAL SPECIFIC SAFETY RULES

GB

a) DANGER: Keep hands away from cutting area and the blade. Keep your second hand on the auxiliary handle, or motor housing. If both hands are holding the saw, they cannot come into contact with the blade.

b) Do not reach underneath the workpiece. The guard cannot protect you from the blade below the workpiece.

c) Adjust the cutting depth to the thickness of the workpiece. Less than a full tooth of the blade teeth should be visible below the workpiece.

d) Never hold the piece being cut in your hands or across your legs. Secure the workpiece to a stable platform. It is important to support the work properly to minimize body exposure, blade binding, or loss of control.

e) Hold the power tool by the insulated gripping surfaces when performing an operation where the cutting tool may contact hidden wiring or its own cord. Contact with a "live" wire will also make exposed metal parts of the power tool "live" and shock the operator.

f) When ripping always use a rip fence or straight edge guide. This improves the accuracy of the cut and reduces the chance of the blade binding.

g) Always use blades with correct size and shape (diamond versus round) of arbor holes. Blades that do not match the mounting hardware of the saw will run eccentrically, causing loss of control.

h) Never use damaged or incorrect blade washers or bolt. The blade washers, flanges and bolt were specially designed for your saw, for optimum performance and safety of operation. Replace with genuine spare parts if damaged or worn.

i) Do not use High Speed Steel (HSS) saw blades
k) Inspect the machine and the blade before each use. Do not use deformed, cracked, worn or otherwise damaged blades.

l) Never use the saw without the original guard protection system. Do not lock the moving guard

in the open position. Ensure that the guard operates freely without jamming.

m) Only use blades that comply with the characteristics specified in this manual. Before using accessories, always compare the maximum allowed RPM of the accessory with the RPM of the machine.

SPECIFICATION

GB

EVO 180 Designed to cut:

Steel Plate:	Max Thickness - 8mm
Steel Box Section:	Max Wall Thickness - 3mm
Stainless Steel:	Blade Change Required
Aluminium:	Blade Change Required
Wood:	Blade Change Required

Motor (230v 50/60 Hz) (Watts) 1250w

Maximum Box Cutting Capacity
90° (3mm wall) 49.5mm

Maximum Box Cutting Capacity
45° (3mm wall) 32mm

Optimum Cutting Thickness (Mild Steel Plate)
6mm

RPM No Load (min-1) 4500

Recommended Maximum Duty Cycle 30mins

Blade Diameter:	180mm
Bore Diameter:	20mm
Thickness:	2mm

Noise and Vibration Data

Sound pressure level: 95.5 dB(A) K 3 dB(A) Sound power level: 104.3 dB(A) K 3 dB(A)

Vibration level: 4.99m/s² K 1.5m/s²

The declared vibration total value has been measured in accordance with a standard test method and may be used for comparing one tool with another.

The declared vibration total value may also be used in a preliminary assessment of exposure.

WARNING: The vibration emission during actual use of the power tool can differ from the declared total value depending on the ways in which the tool is used. The need to identify safety measures and to protect the operator are based on an estimation of exposure in the actual conditions of use (taking account of all parts of the operating cycle, such as the times the tool is switched off, when it is running idle, in addition to trigger time).

Your Evolution Power Tools saw is shipped complete. Remove all contents from the box and inspect to ensure no damage was incurred during shipping, and that the items listed below are included.

ITEMS SUPPLIED

Description	
Instruction Manual:	Qty 1
Allen Key:	Qty 1
180mm Steel Blade (fitted)	Qty 1
Discharge Port Exhaust	Qty 1
Parallel Edge Guide	Qty 1
Carry Case	Qty 1

EVO 180MM STEEL CIRCULAR SAW



1. ON/OFF TRIGGER SWITCH
2. AUXILLARY FRONT HANDLE
3. DISCHARGE EXHAUST PORT
4. LOWER BLADE GUARD
5. FITTED BLADE IN SITU

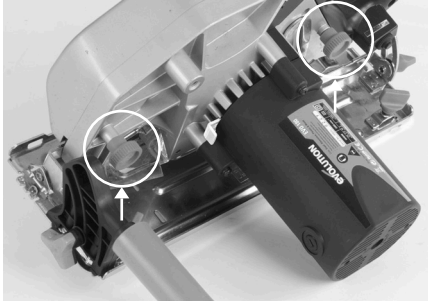

FIG 1

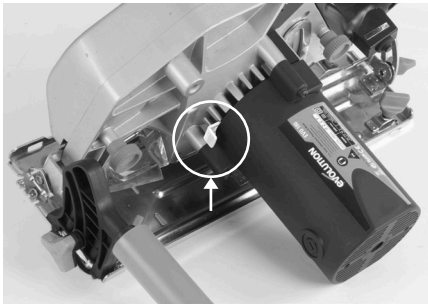

FIG 2



FIG 3

WARNING: Always disconnect the saw from the power source before making adjustments.

Refer to the “Service Parts Diagram”. Install a blade as detailed in the “Installing or Removing a Blade” section.

WARNING: Never start the saw with the cutting edge of the saw blade in contact with the workpiece surface. Do not retract blade guard manually. Guard retracts automatically.

This saw is equipped with an approved cord and plug for its intended Country of use. Do not alter or modify the power cord.

Installing or Removing a Blade

WARNING: Only use genuine Evolution blades which are designed for this machine. Ensure that the maximum speed of the blade is compatible with the machine. Only perform this operation with the machine disconnected from the power supply.

Note: It is recommended that the operator considers wearing protective gloves when handling the blade during installation or when changing the machines blade.

1. Place saw on a level, secure surface.
2. Remove the chip collector from the machine by undoing the (2) large thumb screws. **(Fig. 1)**

Note: The chip collector thumb screws are ‘captive’ and cannot be removed from the machine.

3. Lock the machine arbor by engaging the arbor lock. **(Fig. 2)**
4. Using the supplied Allen Key loosen and remove the arbor socket headed screw and outer blade drive flange. **(Fig. 3)**
5. Remove the saw blade.
6. Thoroughly clean inner and outer blade drive flanges and blade mounting surface before installing a new blade.
7. Ensure that the direction of rotation arrows printed on the blade, match the direction of rotation arrow found on the chip collection cover. **(Fig. 4)**
8. Reinstall the outer drive flange and the arbor socket headed screw.
9. Engage the arbor lock and tighten the arbor socket headed screw securely using the Allen key.

Note : The socket headed arbor screw has a RH thread.



FIG 4

10. Replace the chip collector and securely tighten the two thumb screws.
11. Check that the arbor lock is fully released by manually rotating the blade.
12. Check the operation of the safety guard.

Parallel Edge Guide

A parallel guide (for help when rip cutting) can be fitted to the sole plate of the machine. The guides arms should be inserted into the rectangular slots in the turned up edges of the sole plate, and slid under the locking thumb screws. (Fig. 5)

Note: The edge guide can be fitted to either side of the sole plate and should only be fitted and adjusted with the machine disconnected from the power supply.

Adjust the edge guide so that it is at the required distance from the blade and tighten the two thumb screws. Check that the edge guide is parallel to the saw blade.

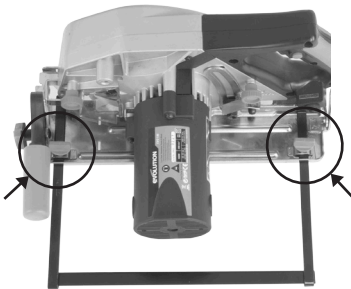

FIG 5

Adjustment of the Cutting Depth

Release the Lever Lock to adjust to the required cutting depth. In most cases depth should be set at maximum unless there are obstructions below the work surface. Tighten the Lever Lock securely to lock in the required position.

Adjustment of the Cutting Angle (Fig. 6)

1. Loosen the Bevel Locking Screw found at the front of the saw.
2. Loosen the Rear Bevel Locking Screw found at the rear of the machines sole plate.
3. Tilt the blade to the required angle. (Fig. 7)
4. Tighten both Bevel Locking Screws securely

Note: An angle scale (0°- 45°) is incorporated into the Bevel Locking quadrant to aid setting.



FIG 6

Operating Advice

Carry out routine safety checks each time you use the machine. Check that all safety guards are operating correctly, and that all adjustment handles/screws are tightened securely.

Check that the blade is secure and installed correctly. Also check that it is the correct blade for the material being cut.

Check the integrity of the power cord.

Always clamp the workpiece to a rigid support such as a bench or saw horse whenever possible.

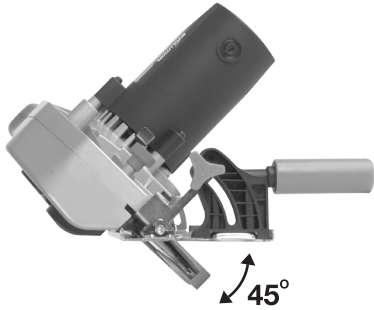

FIG 7



FIG 8



FIG 9

ON/OFF Trigger Switch

This machine is equipped with a safety start trigger switch.

To start the machine:

- Push in the safety lock button on the side of the handle with your thumb.
- Depress the main trigger switch to start the motor. (Fig. 8)

Chip Collector

This machine is fitted with a chip collector to capture metal chips. The chip collector cover plate is provided with a transparent 'window' so that the operator can see the contents and empty when necessary.

To remove and empty the chip collector:

- Loosen the two chip collector thumb screws.
- Ease the chip collector from the machine.
- Empty the contents of the chip collector by tipping the collector upside down over a suitable waste container, allowing the contents to fall out.

Note: To maintain operational efficiency we recommend that the collector is emptied when approximately 60% full. Dispose of the contents of the chip collector in an environmentally responsible manner.

- Replace the chip collector and securely tighten the (2) thumb screws.

Discharge Port

When cutting wood the Discharge Port Exhaust should be fitted to the chip collector cover Discharge Port.

To fit the Discharge Port Exhaust

- Remove the Discharge Port blanking cover by unscrewing the cross headed screw.
- Pull the blanking cover from the Discharge Port and safely store for future use.
- Fit the Discharge Port Exhaust in place of the blanking cover. (Fig. 9) Wood chips will be ejected from the Discharge Port Exhaust during cutting operations.

When cutting has been completed, remove the Exhaust Port and replace the blanking cover and tighten the fixing screw securely.

Cutting Advice

The operator should wear all relevant PPE (Personal Protection Equipment) necessary for the job at hand. This could include safety glasses, dust masks, safety shoes etc.

The operator should always be aware of the position and routing of the power cable.

- Do not force the machine.
- Allow the speed of the saw blade do the work. Cutting performance will not be improved by applying excessive pressure to the machine, and blade life will be reduced.
- When using the parallel edge guide, ensure that it is parallel with the blade. The blade and/or motor could become damaged if the machine is used with an incorrectly adjusted parallel edge guide.
- To set the guide, loosen the two retaining screws, and adjust the guide to the required position. Tighten the locking screws.
- Place front edge of sole plate squarely on the workpiece before starting the motor.
- When starting a cut, sight the cutting line with the line of cut guide, taking care to introduce the blade to the material slowly, so as not to damage its teeth.
- Use both hands to move the saw forwards rough the work piece.
- Apply smooth, constant pressure to move the saw forwards through the workpiece.

When a cut has been completed release the ON/OFF trigger switch and allow the blade to come to a complete halt. Do not apply lateral pressure to the blade disc in an attempt to slow it down more quickly.

WARNING: If the motor should stop or stall whilst a cut is being attempted release the trigger switch immediately and disconnect the machine from the power supply. Remove the machine from the workpiece before investigating the cause and attempting to restart the motor.

Note: This saw is fitted with an overload protection device. This is designed to prevent overloading and consequent damage to the motor. If this feature 'trips', the motor stops and will not operate. Allow the machine to cool down and then press the 'reset switch' at the base of the main handle.

MAINTENANCE

GB

Note: Any maintenance must be carried out with the machine switched off and disconnected from the power supply.

Check that all safety features and guards are operating correctly on a regular basis. Only use this machine if all guards/safety features are fully operational.

All motor bearings in this machine are lubricated for life. No further lubrication is required.

Use a clean, slightly damp cloth to clean the plastic parts of the machine. Do not use solvents or similar products which could damage the plastic parts.

WARNING: Do not attempt to clean by inserting pointed objects through openings in the machines casings etc. The machines air vents should be cleaned using compressed dry air.

Excessive sparking may indicate the presence of dirt in the motor or worn out carbon brushes.

Brush Checking and Replacement To replace the motor brushes:

- Disconnect the machine from the power supply.
- Place the machine on a level, secure surface.
- Remove the (2) motor brush retainer cap screws.
- Withdraw the brushes.

Note: If the Carbon rod is less than 6mm long or if there are signs of burning or damage, replace the brushes.

- Fit the new brushes.
- Refit the motor brush retainer caps.
- Run the saw without load for several minutes after brush replacement to aid the 'bedding in' process.

ENVIRONMENTAL PROTECTION

GB

Waste electrical products should not be disposed of with household waste. Please recycle where facilities exist. Check with your Local Authority or retailer for recycling advice



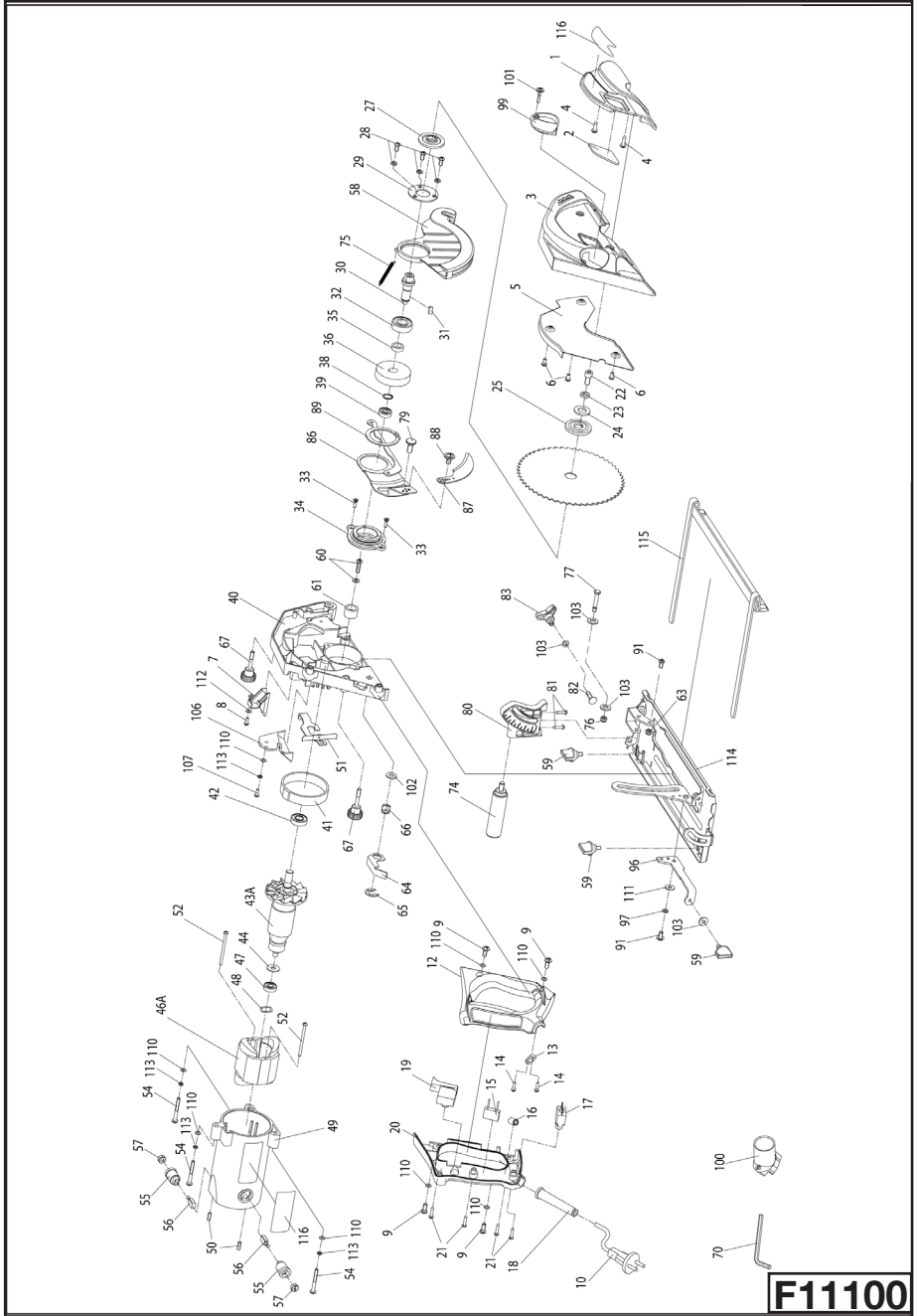

The logo features the word "evolution" in a bold, lowercase, sans-serif font, with a grey curved swoosh underneath it. The word "POWER" is written in a smaller, uppercase, sans-serif font, positioned above the "evolution" text. A registered trademark symbol (®) is located to the right of the word "POWER".

evolution
POWER®

www.evolutionpowertools.com