

TOOLS BUILT TO LAST

Trick-Tools has the largest selection of hardcore, no-compromise metal fabrication tools and equipment on the planet!

OUR PHILOSOPHY:

We believe that long-lasting, quality tools are not only the best value in the end, but something you can enjoy using that will help you take your fabrication to the next level. The products you see in this catalog are hand picked from top manufacturers around the world. We aren't limited to offering you one tool brand, but choose the best in each category and provide options for the home shop as well as high production manufacturing. Let our Solution Specialists help you determine the best tool for your application. When we help you with a recommendation, we are glad to offer our No Junk Guarantee.

"The bitterness of poor quality is remembered long after the sweetness of low price has faded from memory."

-Aldo Gucci

OUR GUARANTEE:

Here at Trick-Tools we believe that our customers deserve lasting value in their tool and equipment purchases. We are constantly searching for high quality, unique and hard to find tools to offer at the best prices possible. Our commitment to you is that we will not offer "cheap junk" anywhere on our website. You, the customer, help us to evaluate our products constantly and as soon as an ongoing quality issue is uncovered we will correct it or discontinue that product immediately. We hope to earn your continued trust.



COME VISIT US!

We are excited to unveil our new office and showroom! Coupled with our existing warehouse, the new addition houses a showroom that will showcase a wide variety of hardcore fabrication tools ranging from hand tools for the home hobbyist, all the way to production machines for industrial applications.

Our new showroom is located at 75 Truman Rd, Pella, IA, just 25 miles south of Interstate 80. Our office hours are from 8:00am - 5:00pm CST Monday through Friday. If you're in the area, we invite you to stop by the new showroom to see the tools on display and see how we can help you take your fab shop to the next level!



FAST

SAME DAY SHIPPING

ON IN-STOCK ORDERS BY 3PM (CST)

3-6 ANGLE FINDERS & LEVELS

Digital Levels · Dial Levels · Bend Protractors · Angle Finders · Plane-Of-Bend Indicators



7-8 BEAD ROLLERS

Bead Form · Bead Rollers · Rotary Machines



9-12 BRAKES & SHEARS

Straight Brakes · Box & Pan Brakes · Slip Rolls · Manual & Hydraulic Shears



13-16 GRINDING & SANDING

Belt Grinders · Combination Belt & Disc Grinders · Deburring Machines
Bench Grinders · Disc Grinders · Knife Making Machines



17-21 IRON WORKERS & PRESSES

Ironworkers · H-Frame Presses · Press Brakes · Louver Press
Bench Presses · Dimple Dies · Punch & Flare Tools



22-28 METAL SHAPING

English Wheels · Planishing Hammers · Tapered and Straight T-Dollies
Shrinker/Stretchers · Mallets and Shot Bags · Educational Books and Videos



29-31 PUNCHING & DRILLING

Sheet Metal Cutters · Drilling Jigs · Hand Punches · Bench Punches
Mag Drills · Drill Presses · Annular Cutters · Flowdrill



32-35 SAWS

Circular Cold Saws · Portable Metal Cutting Saws · Horizontal Band Saws
Mitering Band Saws · Vertical Band Saws · TCT Chop Saws



36-43 TUBE BENDERS

Design & Layout Software · Rotary Draw Benders · Mandrel Bending Machines
Hand Bending Machine · Roll Bending Machines · Exhaust Benders



44-48 TUBE NOTCHING & ENDFORMING

Abrasive Notching Machines · Hole Saws · End Mill Notchers · Hole Saw Notchers
Pipe Notchers · PipeMasters · Portable Expanders · Tubing Swager



49-56 WELDING & PLASMA CUTTING

Variable Angle Clamps · Fixed Angle Clamps · Rotary Welding Positioners · Fixturing Tables
Header Modeling Systems · Plasma Tube Cutter · CNC Plasma Tables



57-58 WORKBENCHES & ORGANIZATION

Workbenches · Fabrication Tables · Versa-Mount Tool Accessories



Terms: We ship UPS and accept Visa, Mastercard, American Express, Discover, and PayPal. Shipments via common carrier must be prepaid and will be FOB point of origin. No returns without prior approval. No returns after 30 days. Products must be in original package in new/unused condition. Returns must be shipped prepaid. A 15% restocking fee will be applied. Any claims for damage or loss must be filed with carrier by purchaser. Prices and specifications subject to change.

Lease Terms: Posted lease prices are based off of the products pricing at the time of printing and a customers best possible credit score. All posted lease pricing is subject to change and is not a guaranteed price. See website for online application and 30 second approval.

WIXEY

DIGITAL ANGLE GAUGE

- Perfect for finding true bevel angles on a saw and track rotation of a tube when tube bending
- Gauge can be "zeroed" at any point
- Large backlit display
- Features a strong magnetic base
- Accurate to .1°
- Includes additional battery
- Optional base attaches to round tubing or pipe that is 3/4 inch through 2 inch OD



- WR300-T2 Digital Angle Gauge**\$29.99
- Digital Angle Gauge and Tube Rotation Bracket Combo**\$89.98
- Tube Rotation Bracket Only** (attaches to 3/4"-2" round tube).....\$59.99

ANGLE LEVEL II

DIAL LEVEL



- Critical for projects demanding accurate angle measurements
- Angle Level settles smoothly to the angle due to its oil damped, ball bearing movement
- Features a strong magnetic base allowing hands free use on ferrous materials
- Accurate up to .1 degree
- Carrying case included

- Angle Level 2** (1/10°) (3.6" x 3.1") \$59.95
- Angle Level 3** (1/20°) (5.5" x 5", die cast housing) \$169.95

TUBE ROTATION GAUGE

ALB Combo

- Useful in bending and notching to track tube rotation
- Accurate up to 1/10 degree
- The powder coated steel base clamps securely on round tubes
- Great for chassis or exhaust work



- ALB Angle Level Base** (up to 2" tube) \$34.95
- ALB Combo** (Includes Angle Level 2 & ALB) Save \$15! \$79.90

HUTH

ROTATION GAUGE



- Perfect for large diameter tube bending applications such as exhaust, turbo, and cold air intake systems
- Accurate up to 1°
- Features a 0-360° range and has a capacity of 1-3/4 - 3" OD

- 996 Clockwise Rotation** (Huth bend cards).....\$260.50
- 976 CC Counter-Clockwise Rotation** (Non-Huth bend cards)\$260.50

DIGI-PAS

DIGITAL LEVELS



DWL80E

- The DWL80E is a handy pocket-sized digital level great for hobbyist and professional use.
- Displays degrees and percent of slope
- Made from impact resistant materials and features a magnetic v-groove base for working with round and flat material.
- **Range:** 0 - 90° • **Resolution:** 1/10° at 0 and 90° | 1/5° at all other angles
- **Accuracy:** 1/10° • **Dimensions (LxWxH):** 4.25" x .5" x 2"

- Digi-Pas DWL-80E Digital Level** (0.10° accuracy) \$29.90
- Digi-Pas DWL-80Pro Digital Level** (0.05° accuracy) \$39.90

ANGLE FINDERS & LEVELS

DIGI-PAS

DIGITAL LEVELS

- Displays in degrees and percent of slope
- Illuminated Display automatically rotates for inverted readings.
- Features an aluminum rail construction and features two bubble levels

- **Range:** 0-90°
- **Resolution:** 1/20° at 0 and 90° 1/5° at all other angles
- **Accuracy:** 1/10°

DWL280Pro



DWL680Pro



DWL280Pro Waterproof Digital Torpedo Level (9.25" x 2.5") \$59.90
 DWL680Pro Waterproof Digital Torpedo Level (24.5" x 2.5") \$115.00

DIGI-PAS

MACHINIST LEVEL

- Designed for leveling and aligning precision welding tables, milling machines, fixturing, surface grinding, etc.
- Instant single access display measurements of both X or Y axis
- Connect to Smartphone via Digi-Pas Machinist App for remote operation up to approx. 50 feet.

- **Accuracy of DWL1300XY:**
+/- 0.004° from 0 - 0.5°
+/- 0.04° from 0.5 - 5°
- **Accuracy of DWL1500XY**
+/- 0.0004° from 0 - 0.5°
+/- 0.004° from 0.5 - 2°



DWL-1300XY (0 - 5° range, 1/100° res) **SALE!** \$199.00
 DWL-1500XY (0 - 2° range, 1/1000° res) **SALE!** . . . \$385.00

SMART TOOL

DIGITAL LEVEL



- Accurate to .1°
- Displays degrees, slope %, and pitch (in/ft) with arrows to show the direction to move towards level
- Gauge can be "zeroed" at any point
- Display inverts when the tool is moved beyond 90 degrees
- Battery (9 volt) lasts about 400 hours of use

Digital Smart Tool (module only) **SALE!** \$151.36

CHECKPOINT

TORPEDO LEVELS

- Designed for portability, efficiency, and professional durability
- Made from anodized billet aluminum
- Features multiple precision vials for horizontal, vertical and other varying degrees of measurement
- Incorporates rare earth magnets on flat bottom surface for a secure hold



305 Ultra Mini Mag G4 **SALE!** \$34.99
 300 Ultra Pro Mag G3 **SALE!** \$37.99
 327, 880 G3 Laser Level with Magnets **SALE!** \$99.99

WIXEY

DIGITAL PROTRACTOR



WR410

- Range: +/- 180°
- Resolution: 0.1°
- Accuracy: +/- 0.1°
- Auto shutoff for extended battery life
- Legs are 2 inches wide
- Built-in magnets on the edge of the legs
- Legs can be tightened for holding measurement

WR410 Digital Protractor (9" long legs) \$67.99
 WR418 Digital Protractor (18" long legs) \$74.99

ANGLE FINDERS & LEVELS

CCKL CREATOR ANGLE FINDERS

- Find any inside or outside angle between 10° to 170°. Choose from four different models.

Angle Finder I (plastic 6")	\$9.95
Angle Finder II (aluminum 20")	\$39.95
Angle Finder III (stainless 4")	\$59.95
Angle Finder IV (stainless 20")	\$79.95

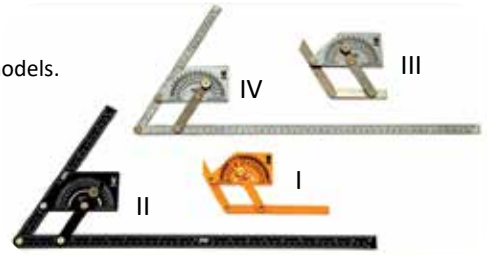

MITTLER BROS. BEND PROTRACTORS

- These high-quality bend protractors will help you duplicate bends that are found in existing parts.
- Easy to set for any degree of bend from 0° to 90°
- Can be used as a bend template or degree indicator
- Inner scale shows degree of bend
- Outer scale shows length of tube consumed in a bend
- Precision CNC engraving
- Anodized aluminum construction



4" Centerline Radius Protractor	\$120.00	7" Centerline Radius Protractor	\$150.00
5" Centerline Radius Protractor	\$130.00	8" Centerline Radius Protractor	\$160.00
6" Centerline Radius Protractor	\$140.00	Complete Set of all five Protractors 4" through 8"	\$575.00

ANGLE FINDERS & LEVELS

ARC-MASTER RADIUS GAUGES



- Proven to speed up complicated calculations and fabrication of bent materials
- Used in applications such as handrails, spiral staircases, aircraft parts, and much more
- Kit includes two versions of the tool to accurately measure inside and outside radius of a piece
- Invaluable companion to any tube bender or slip roll



ArcMaster Large Radius Kit (6" - 144" Range)	\$229.99
ArcMaster Small Radius Kit (2.5" - 30" Range)	\$129.99

TRICK-TOOLS RADIUS CHECK GAUGE

- This robust acrylic radius gauge from Trick-Tools is a valuable addition to any metal shaper's tool box.
- Great for duplicating contours and assuring consistency in radiused sheet metal parts
- Provisions for 0, .75, 1, 1.25, 1.5, 2, 3, 4, 6, 12, 24, and 36 inch radii
- Invaluable in choosing the proper hammer, dolly, anvil wheel or planishing die to match your part



Trick-Tools Radius Check Gauge	\$19.99
--------------------------------	-------	---------

TRICK-TOOLS

ADJUSTABLE RIVET SPACER

- Use this spacer to layout the spacing of rivets, bolts, nails, etc. equally over a length of up to 36 inches of material.
- Index lines at 3/4", 1", 1-1/4", and 1-1/2" assist in accurate and consistent hole spacing.
- Great for creating artistic patterns for bead rolling, custom furniture, race car, and aircraft fabrication.
- Stainless Steel construction for durability

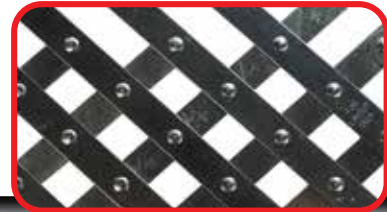

20 Hole Adjustable Rivet Spacer \$45.00

TRICK-TOOLS

HOLE FINDER KITS



- Use to locate rivet holes in overlapping panels
- These handy tools are extremely useful for riveting two layers of sheet metal together or when riveting sheet metal to any structure which already has holes drilled in it.
- Insert pilot pin into the existing hole and use the hardened bushing on the opposite strap to guide the drill bit.
- Sold in a 5 piece set, including #40, #30, #21, #10, and 1/4 inch.



13060 Standard Hole Finder Kit, 6 inch \$29.50
 13062 Inverted Hole Finder Kit, 6 inch \$31.20
 13230 Standard Hole Finder Kit, 13 inch \$40.95

NIELSEN

TRANSFER SCREWS

- Nielsen Transfer Screws align the location of threaded holes with a blank piece of sheet metal or plate.
- Thread self-aligning transfer screw into a threaded hole, place the blank over the punch, and strike with a dead blow hammer.
- The center point of the hole, as well as the diameter of the hole, will be transferred to your blank.
- Made from case hardened steel



Individual Sizes, 12 pieces (10-24 through 3/4"-16) Starting at \$28.99 ea.
 Nielsen Transfer Screw Kit, 8 piece (includes 1 of each size from #10 to 3/4, available in coarse or fine thread kits) \$29.99 ea.
 Nielsen Transfer Screw Kit, 32 piece (includes 4 of each size from #10 to 3/4, available in coarse or fine thread kits) \$79.99 ea.
 Nielsen Transfer Screw Kit, 64 piece (includes 8 of each size from #10 to 3/4, available in coarse or fine thread kits) \$204.99 ea.

JAMEY JORDAN

BEAD ROLL LAYOUT KIT



- This 4 piece layout template kit includes everything you need to make unique and creative designs when bead rolling sheet metal.
- Each template ensures a perfect arc, circle, straight line, or rivet location.
- Each template is designed to space each profile evenly for a consistent look throughout your project.
- Made from 1/8 inch anodized aluminum with laser engraved markings
- Made in the USA

Jamey Jordan Series Layout Template Set, 4 piece (includes Arc, Straight, Circle, and Rivet Tool Templates) SALE! \$340.00

ANGLE FINDERS & LEVELS

FOLLOW US ON SOCIAL MEDIA:



MITTLER BROS. BEAD ROLLERS

Finance as low as \$40.00 / Month

- Mittler Bros Bead Rollers are designed to handle .040" mild steel (20 ga.), .050 inch aluminum, or up to 16 ga. steel, .060 inch aluminum with industrial motor upgrade.
- Largest selection of heat treated rolls to choose from
- Adjustable depth of bead
- Variable speed foot control allows for hands free operation
- Oilite bushings at all rotation points for long life
- Heat treated gears for years of trouble free operation
- 1-1/8 inch throat height
- Forward and reverse switch for left or right side operation
- Deluxe Kits include: 1/4" round, 1/16" step, spoiler roll, 1/2" flat bead, tipping roll, art pattern roll, and rolling pedestal.



210-24-K



200-36NV-K



Scan for Video

24" Manual Bead Roller	\$850.00
24" Power Bead Roller (add \$725 for industrial motor)	\$1,150.00
24" Power Bead Roller Deluxe Kit SALE!	\$1,625.00
24" Industrial Power Bead Roller Deluxe Kit SALE!	\$2,490.00
36" Power Bead Roller (add \$725 for industrial motor)	\$1,375.00
36" Industrial Power Bead Roller Pro Racer and Restoration Kit SALE!	\$2,700.00
42" Power Bead Roller	\$1,820.00

(See our website for over 150 Mittler Bros. Roll Profiles)



BEAD FORM TOOLS

JAMEY JORDAN SERIES BEAD ROLLERS

Finance as low as \$61.00 / Month

- The Jamey Jordan Signature Series Bead Roller by Mittler Brothers is perfect for custom built sheet metal panels in street rods, aircraft restorations, and race cars.
 - These machines feature an adjustable upper shaft for greater flexibility with bead profiles, ideal for special effects in metal art.
 - Variable speed foot pedal control and reversible 110 volt motor
 - Capacity is rated for 16 gauge steel and .060 inch aluminum
 - Options include rolling pedestal, adjustable depth stop, and work table.
- Throat Depth (inches): 24" and 36" • Throat Height (inches): 1-1/8
 • 24" Construction: billet aluminum • 36" Construction: fabricated steel

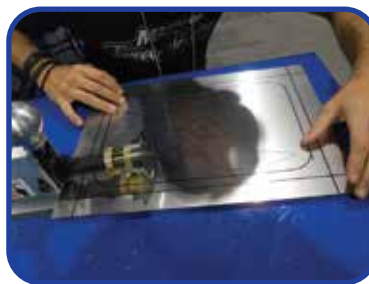

202-24NV-K

24" Power Bead Roller (add \$855 for industrial motor)	\$1,260.00
24" Industrial Power Bead Roller Deluxe Kit SALE!	\$2,910.00
36" Power Bead Roller (add \$715 for industrial motor)	\$1,720.00
36" Industrial Power Bead Roller Deluxe Kit SALE!	\$3,215.00
Work Table for Mittler Bros. Bead Roller	\$290.00
Layout Template Kit (includes arc layout, straight line, and hole layout templates)	\$265.00
Art Roll Kit (includes: Art Roll, Solid Roll, Solid Groove Roll, and Universal Groove Roll) ..	\$240.00
Art of Bead Rolling DVD Vol. 1 (By Jamey Jordan, 35 min)	\$25.00
Art of Bead Rolling DVD Vol. 2 (By Jamey Jordan, 35 min)	\$30.00



PEXTO

ROTARY MACHINE

- This Pexto 622 forming machine offers a variety of shapes and capabilities for a combination of uses: beading, crimping, double seaming, turning, burring, wiring, elbow edging, flanging, and flattening.
- The 622 Series is equipped with the addition of a 7 inch deep throat for additional forming capabilities.
- The 622 includes 5 sets of rolls and gauges or may be ordered without rolls as the 622LR.
- 24 gauge mild steel capacity



622

622 Pexto Rotary Machine (includes Pexto 622, bench mounting base, and rolls) **\$1,339.00**
622LR Pexto Rotary Machine (less rolls) **\$1,053.00**

BAILEIGH

HD BEAD ROLLER

 Finance as low as
\$169.00 / Month



- The BR16E-36 Bead Roller features a 36" deep x 12" high throat - the largest available on the market!
- The bead roller is equipped with a variable speed frequency drive with a foot pedal control, giving the operator unlimited speed adjustment.
- Another unique feature is the quick release upper die that allows the upper roll to be disengaged from the material, allowing the operator to begin or end a design in the middle of a panel.
 - Steel Capacity: 16 gauge
 - Aluminum Capacity: .065"
 - Stainless Capacity: 20 gauge
 - Throat Depth: 36"
 - Throat Height: 12"
 - Motor: 1/2 hp 110v

BR-16E-36 Power Bead Roller SALE! **\$7,239.00**
Roll Sets **Starting at \$156.35 ea.**

MITTLER BROS.

TALL THROAT BEAD ROLLERS



- This version of the popular Mittler bead roller allows the beading of high crown panels or pan shaped pieces, in addition to flat sheet metal.
- This unit comes standard with a variable speed electric motor and foot pedal controls.
 - Variable speed foot control
 - Forward/Reverse switch
 - 4" tall throat
 - Includes one standard roll set
 - .040" mild steel or .050" aluminum capacity
 - Upgraded motor available for 16 ga applications

24" Throat Model (add \$730 for industrial motor) **\$1,320.00**
36" Throat Model (add \$725 for industrial motor) **\$1,700.00**
Standard Roll Sets **Starting at: \$105.00**
High Crown Roll Sets **\$265.00**

JAMEY JORDAN SERIES

- Jamey Jordan Bead Rollers feature an adjustable upper shaft for greater profile flexibility
- Popular for metal art and special effects
- Deluxe kit includes: industrial motor option, a 5/16 inch round bead roll, 1/16 inch step roll, spoiler bead roll set, rolling stand, roll holder, and depth stop.
- High throat adapter kit accessory allows you to use standard Mittler Bros bead roll sets and all Jamey Jordan Signature Series Art Rolls with your high throat machine.
- High throat work table accessory allows for greater control of flat panels

24" Jamey Jordan Series High Throat Bead Roller (add \$765 for industrial motor) **\$1,690.00**
24" Jamey Jordan Series High Throat Bead Roller Deluxe Kit SALE! **\$3,113.70**
36" Jamey Jordan Series High Throat Bead Roller (add \$755 for industrial motor) **\$2,010.00**
36" Jamey Jordan Series High Throat Bead Roller Deluxe Kit SALE! **\$3,414.40**
202-200-HT High Throat Work Table Accessory **\$355.00**



BEAD FORM TOOLS

BEVERLY THROATLESS SHEARS

- Throatless design lets you turn your work at any angle for straight, curved, and irregular cuts.
- Upper and lower blades are positioned to provide a clean, knurl-free cut, regardless of material thickness.
- Easily cuts mild steel and stainless using tool steel blades
- Drilled for work bench mounting
- SS-2 and SS-3 slitting shears are available for making straight cuts in long sheets of material.



Scan for Video

Model	B-1	B-2	B-3	SS-2	SS-3
Capacity (Mild Steel)	14 ga.	10 ga.	3/16"	10 ga.	3/16"
Capacity (Stainless Steel)	18 ga.	14 ga.	10 ga.	14 ga.	10 ga.
Blade Length	4.25"	4.375"	5.375"	3.5"	4.25"
Weight	18 lbs.	36 lbs.	58 lbs.	11 lbs.	25 lbs.

- B-1 Beverly Shear \$665.00
- B-2 Beverly Shear \$915.00
- B-3 Beverly Shear \$1,325.00
- SS-2 Beverly Slitting Shear \$415.00
- SS-3 Beverly Slitting Shear \$590.00

FEIN SLITTING SHEARS

- FEIN shears are suited for quick and warp-free cut-outs in sheet metal.
- The QuickIN feature offers tool free blade changing with no further adjustments.
- Variable speed motor is easily adjustable for increased control
- FEIN products utilize outstanding ergonomics and compact design for optimal mobility.
- Excellent tools for sheet metal shops, race shops, HVAC work, and electrical installation.
- Corded and Cordless options are available!



Scan for Video

- BSS 1.6E Slitting Shear (16 ga. 110v) **SALE!** \$679.00
- BSS 1.6CE Slitting Shear with Chip Cutter (16 ga. 110v) **SALE!** \$759.00
- BSS 2.0E Slitting Shear (14 ga. 110v) **SALE!** \$989.00
- ABSS18-1.6E Cordless Slitting Shear Kit (16 ga. 18v Li-ion Battery) **SALE!** \$689.00

FEIN SHEET METAL NIBBLERS



- FEIN Sheet Metal Nibblers are a portable metal cutting tool for cutting corrugated sheet metal, steel roofing, and many other profiles.
- FEIN products utilize outstanding ergonomics and compact design for optimal mobility.
- The QuickIN feature offers tool free change of punches and dies with no further adjustments.
- Cutter life is greatly improved with a punch that rotates 90 degrees per stroke.

- BLK1.3CSE Variable Speed Sheet Metal Nibbler (18 ga. 110v) **SALE!** \$719.00
- BLK3.5 Sheet Metal Nibbler (10 ga. 110v) **SALE!** \$1,929.00
- ABLK18-1.6E Cordless Sheet Metal Nibbler (16 ga. 18v Li-ion Battery) **SALE!** \$669.00

MIDWEST AVIATION SNIPS



- Aviation snips are great for light sheet metal cutting and trimming
- Ergonomic handle reduces muscle stress and requires less hand force
- Useful in race car, heating and cooling, aircraft, and construction work
- Cuts completely to blade tip end which reduces cutting strokes and enables accurate trim cuts.
- Made in the U.S.A.

Offset Snips



Scan for Video

- Aviation Snips (left, right, or straight cut) **SALE!** \$17.16 ea.
- Aviation Snips, 3-piece Set **SALE!** \$52.49
- Offset Aviation Snips (left, right, or straight cut) **SALE!** \$22.32 ea.
- Offset Aviation Snips, 2-piece Set (left and right) **SALE!** \$42.44

METALACE RADIUS BRAKES

Finance as low as
\$89.00 / Month

- These Radius Brakes are the perfect solution for forming radius bends in mild steel and aluminum.
- Stress cracking of material is eliminated due to the unique design of the apron.
- Especially useful in race car fabrication, as well as automotive and aircraft restoration work.
- 6 radius rollers included with 4 ft machine: 1, 2, 3, 4, 5, and 6-5/8 inch OD
- 5 radius rollers included with 6 ft & 8 ft machine: 1, 2, 2-1/2, 3 and 4 inch OD

Model No.	4FT.	6FT.	8FT.
Mild Steel Capacity	16 ga. (.063")	16 ga. (.063")	18 ga. (.049")
Aluminum Capacity	.090"	.090"	.063"
Maximum Bend Length	48"	72"	96"
Weight	750 lbs.	850 lbs.	1,090 lbs.



Scan for Video



RB4816



4-Foot Radius Brake	\$5,195.00
6-Foot Radius Brake	\$5,849.00
8-Foot Radius Brake	\$7,149.00
MetalAce Radius Brake Back Gauge	\$195.00

TENNSMITH MANUAL SLIP ROLLS



SR24

- Combines precision-turned and polished high carbon steel rolls with cast iron end frames.
- Features large roll adjusting screws and front handle to lift upper roll for material removal.
- 3-driven roll machines allow for greater traction on hard to bend materials.

SR24, 24" Slip Roll (2 driven rolls, add \$295 for Floor Stand)	\$905.00
SR36, 36" Slip Roll (2 driven rolls, add \$335 for Floor Stand)	\$1,035.00
SR42, 42" Slip Roll (2 driven rolls, add \$365 for Floor Stand)	\$1,150.00
SR48, 48" Slip Roll (3 driven rolls, add \$555 for Floor Stand)	\$4,095.00

Model No.	SR24/SR324	SR36/SR336	SR42/SR342	SR48
Capacity (Mild Steel)	20 ga.	22 ga.	24 ga.	16 ga.
Max. Forming Length	24"	36"	42"	48"
Diameter of Rolls	2"	2"	2"	3"
Min. Forming Radius	1"	1"	1"	1-1/2"
Wire Grooves	3/16", 1/4", 5/16"	3/16", 1/4", 5/16"	1/4", 5/16", 3/8"	3/8", 1/2", 5/8"
Ship Weight	190 lbs.	250 lbs.	270 lbs.	775 lbs.

NATIONAL POWERED SLIP ROLLS

Finance as low as
\$229.00 / Month

- National's electric powered Slip Rolls feature 3 inch power rolls designed for simple operation.
- Designed for production rolling of light gauge sheet metal into curved panels.
- The powered rolls are precision turned, ground, and polished high carbon steel.
- All three rolls are power driven and come with a standard forward and reverse drum switch.
- These machines feature a quick release upper roll, positive chain drive, and a HD gear box.
- Available in 110/220v 1ph and 220/440v 3 ph.



NR7216

NR4816 (48" working length, 16 gauge mild steel capacity)	\$7,587.80
NR7216 (72" working length, 16 gauge mild steel capacity)	\$9,223.50



QUALITY TOOLS BACKED BY OUR NO JUNK GUARANTEE

BRAKES & SHEARS

BOYD-BUILT RACER BRAKE

Finance as low as \$53.00 / Month



- 7 foot sheet metal brake is ideal for race car bodies, HVAC work, and more.
- Includes 1 inch radius bar for optional radius bending.
- Adjustable tension bars, adjustable counterweights, and plate steel construction make these brakes a great value for a fabricator on a budget.

Boyd-Built 7ft Racer Brake \$2,160.00

SPECIFICATIONS	7FT.
Mild Steel Capacity	20 ga.
Aluminum Capacity	.060"
Minimum Flange @ Capacity	5/8"
Weight	495 lbs

MITTLER BROS. ULTIMATE BOX & PAN BRAKE



Finance as low as \$98.00 / Month

- These brakes feature a "3 finger" design, incorporating movable fingers on the bed and apron, as well as the usual upper fingers, perfect for extremely difficult bend combinations.
- Unit ships standard with: 1", 2", 3", 6", 12", 24" Upper Fingers, Bed Fingers, and Apron (leaf).
- Ultimate Box & Pan Brake is capable of creating a 3-1/2 inch depth of box, and has a minimum flange capacity of 1 inch.



Scan for Video

Ultimate Box & Pan Brake (48" benchtop, 16 ga capacity) \$4,250.00
 48" Floor Stand \$310.00
 Ultimate Box & Pan Brake (72" floor, 18 ga capacity) \$6,975.00

MITTLER BROS. ULTIMATE FOOT SHEAR

Finance as low as \$155.00 / Month



3000-72-24

- Designed with the fabricator in mind, these shears are the most economical way to accurately cut large pieces of material.
- Mittler Shears feature a reversible blade, adjustable blade clearance, adjustable hold down pressure, and a precision fabricated steel construction.

SPECIFICATIONS	3000-52-16	3000-72-24
Mild Steel Capacity	16 ga.	24 ga.
Aluminum Capacity	.080"	.040"
Cutting Length (inches)	52	72
Cutting Width (inches)	52	72
Price	\$3,990.00	\$6,250.00

BAILEIGH MAGNETIC BRAKES

Finance as low as \$80.00 / Month



- Baileigh magnetic sheet metal brakes feature nearly endless bending possibilities.
- Capable of forming boxes to almost any depth due to their unlimited finger depth
- Features a stroke angle control that can be set for repeatable bends
- Includes a back gauge, full clamping bar, and box finger set
- 16 ga. mild steel capacity
- 220v 1ph power for easy placement

BB-4816M (48" working length, 16 gauge mild steel capacity) SALE! \$3,499.00

TENNSMITH SHEARS

Finance as low as
\$81.00 / Month

52-TEN

Tennsmith offers a wide variety of quality brakes and shears. These heavy duty units offer industry leading features such as replaceable nose bars, high-chromium blades, and cast frame construction. A wide range of machines covers 4 to 12 foot widths and 22 gauge through 12 gauge capacity. These U.S.A. made machines feature a 3-year manufacturer's warranty.



36 inch Foot Shear, 16 gauge	\$2,599.00
36 inch Air Powered Shear 16 gauge.....	\$4,850.00
52 inch Foot Shear, 16 gauge	\$3,295.00
52 inch Air Powered Shear, 16 gauge	\$5,995.00
52 inch Hydraulic Powered Shear, 16 gauge.....	\$7,350.00
120 inch Manual Shear, 20 gauge	\$12,250.00

BENCHTOP BRAKES

Tennsmith's bench mounted hand brakes are rugged, dependable USA-made tools that won't break your budget. Tennsmith's bench mounted hand brakes provide an economical means of performing a wide range of sheet metal bending and forming operations. These brakes are of all steel welded construction, readily adjustable, and utilize bronze bearings at the pivot points.

48 inch Benchtop Straight Brake, 22 gauge	\$750.00
48 inch Benchtop Straight Brake, 16 gauge	\$1,390.00
48 inch Benchtop Box & Pan Brake, 22 gauge	\$965.00
48 inch Benchtop Box & Pan Brake, 16 gauge	\$1,595.00
Shear and Box & Pan Brake Combo (Model 52 Shear and HBU48-16 Brake) SALE!	\$4,955.00
Optional Floor Stand for Benchtop Units	\$245.00



Finance as low as
\$39.00 / Month

NATIONAL STRAIGHT BRAKES

National brakes are heavy duty, U.S. built machines featuring simple designs with the utmost strength, for a long life of dependable service. Their convenient, streamlined design means that even the sheet metal novice can bend material quickly and accurately. National machines are built from a heavy steel body with heavy tie rods for perfect alignment and precision bearings in the apron assure a smoothly operating brake for years to come.

72 inch Straight Brake, 12 gauge	\$4,639.80
96 inch Straight Brake, 16 gauge	\$4,850.00
96 inch Straight Brake, 14 gauge	\$5,195.30
120 inch Straight Brake, 16 gauge	\$6,655.00
120 inch Straight Brake, 14 gauge	\$7,095.00

Finance as low as
\$104.00 / Month



BOX & PAN BRAKES

Box and pan brakes or 'finger brakes' have removable 2, 3, and 4 inch fingers to allow complex bending of sheet metal not attainable with straight brakes. Find the working length and gauge capacity that best fits your needs.

48 inch Box & Pan Brake, 16 gauge	\$1,518.00
48 inch Box & Pan Brake, 12 gauge	\$4,611.20
72 inch Box & Pan Brake, 16 gauge	\$5,251.40
72 inch Box & Pan Brake, 12 gauge	\$5,720.00
96 inch Box & Pan Brake, 16 gauge	\$6,187.50



Finance as low as
\$134.00 / Month

BRAKES & SHEARS

MULTITOOL BELT GRINDERS

- Available as motorized unit or attachment only to upgrade your existing grinder
- Removes material up to five times faster than with the equivalent grit grinding wheel.
- Multitool features 5 grinding positions: contact wheel, flat platen, slack belt, disc and grinding wheel.
- Belts change in seconds from grinding to sand deburr or polish
- Backed by a 1-year warranty



362-8

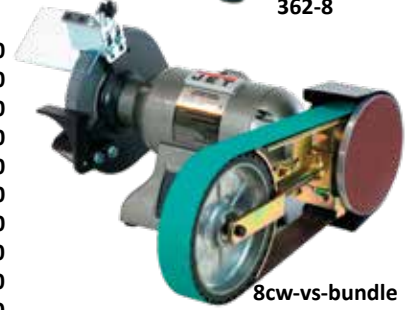

8cw-vs-bundle

MT362 Multitool Grinder Attachment (2" x 36" belt)	\$229.00
MT362-8 Multitool Grinder (2" x 36" belt, w/ 1 hp grinder).....	\$495.00
MT482 Multitool Grinder Attachment (2" x 48" belt)	\$309.00
MT482-8 Multitool Grinder (2" x 48" belt, w/ 1 hp grinder).....	\$539.00
MT364 Multitool Grinder Attachment (4" x 36" belt).....	\$349.00
MT364-8 Multitool Grinder (2" x 36" belt, w/ 1hp grinder)	\$599.00
MT484 Multitool Grinder Attachment (4" x 48" belt)	\$359.00
Multitool 8CW Belt Grinder Attachment (2" x 48" belt, 8" contact wheel)	\$389.00
Multitool 8CW with Variable Speed Motor Bundle (2" x 48" belt, 8" contact wheel)	\$888.00
Disc Grinder Miter Attachment SALE!	\$69.00

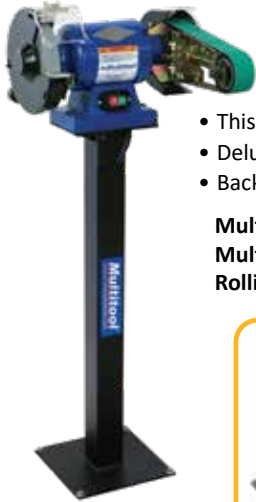

DELUXE KIT

- This Kit offers the same performance that Multitool is known for but offers even more versatility.
- Deluxe kit includes a 90 degree tilting floor pedestal, horizontal work table, and abrasive belt starter kit.
- Backed by a 1-year warranty



Scan for Video

Multitool 2" x 36" Belt Grinder Deluxe Kit	\$659.00
Multitool 2" x 48" Belt Grinder Deluxe Kit	\$699.00
Rolling Base	\$159.95



RADIUSMASTER BELT GRINDER

Finance as low as
\$67.00 / Month



- Offers a higher level of performance and convenience, plus greater versatility and durability than any general purpose machine
- Choose from 7 grinding surfaces including 5 radius wheels, slack belt and platen grinding
- Tilts on the side to be used as a bobbin grinder
- Fully sealed bearings

- Belt size: 48 x 2 inch
- 1.5 hp, 110v (overload protected)
- Belt speed: 3,600 feet per minute
- 1 year manufacturer's warranty
- Standard equipment includes tilting pedestal, vertical platen, small wheel platen



Scan for Video

RadiusMaster Belt Grinder (add \$900.00 for variable speed option).....	\$2,695.95
RadiusMaster Deluxe Kit (includes horizontal platen, rolling base, and belt starter kit) SALE!	\$2,995.95
Rolling Base for RadiusMaster	\$159.95
Drive Wheel Tool Rest for RadiusMaster	\$295.95
Hollow Grinding Jig for RadiusMaster	\$395.95



GRINDING & SANDING

HARDCORE

MAXIMIZER BELT GRINDER



Finance as low as \$137.00 / Month

- Seven different work stations available and can be used in vertical or horizontal configurations
- Micro adjustments for belt tensioning and tracking control are made quickly and easily.
- Optional contact wheels can go up to 10 inch
- 5/16 inch through 2 inch contact wheels are available with optional Small Wheel Attachment

- Includes rotating and tilting pedestal
- 1.5 hp motor, 4,500 RPM
- Infinite variable speed motor
- Belt Dimensions: 2 x 72 inch
- 8 work rests
- Billet aluminum construction

Hardcore BGA-6 Belt Grinder (110v/220v 1ph) \$5,549.00
 Small Wheel Attachment (small wheels and work rest sold separately) \$275.00

HARDCORE

6"x60" BELT GRINDER

Finance as low as \$70.00 / Month

- Hardcore Belt Grinders are precision machines designed and balanced for vibration free operation.
- Micro adjustments for belt tensioning and tracking control are made quickly and easily.
- This premium unit utilizes a billet aluminum construction.

- 1.5 hp motor, 2,500 RPM
- Variable speed motor
- Dimensions (LxWxH): 21"x 22"x 30"
- Belt Dimensions: 6 x 60 inch
- Quick belt change & tracking



Hardcore BGA-6 Belt Grinder (110v/220v 1ph) \$2,850.00

HARDCORE

2"x72" BELT GRINDER

Finance as low as \$67.00 / Month



Scan for Video

- Hardcore grinders are popular machines among race car fabricators and knife makers.
- Balanced for vibration free operations
- All adjustments are quick and easy with micro adjustments for belt tensioning and tracking.

- 2 x 72 inch belt
- 8 inch contact wheel
- Billet aluminum construction
- 1.5 hp motor

Hardcore BGA-V Belt Grinder (110v/220v 1ph, Variable Speed Motor) \$2,699.00
 Hardcore BGA-E Economy Belt Grinder (110/220v 1ph, Single Speed Motor) \$1,699.00
 SWA-P Small Wheel Attachment (wheels sold separately) \$165.00
 DGA-P Disc Grinder Assembly \$389.00
 FPA-P Flat Platen Attachment \$369.00

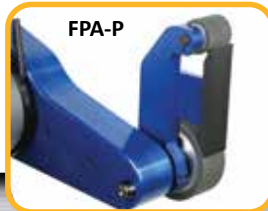

HARDCORE

DISC GRINDER

Finance as low as \$64.00 / Month

- Hardcore Disc Grinders are precision machines designed with aerospace tolerances.
- Balanced for vibration free operations
- Removable work rest adjusts from 45 to 90 degrees

- 1.5 hp motor, 1735 RPM
- Reversible/variable speed
- 12 inch Disc
- Billet aluminum construction



Hardcore DG-12 Disc Grinder \$2,599.00

FOLLOW US ON SOCIAL MEDIA:



GRINDING & SANDING

BURR KING X400 BELT GRINDER

Finance as low as \$42.00 / Month

- The Burr King X400 features a 2 x 48 inch belt, US made 1 hp motor, heavy cast construction, and all of the precision and smooth running qualities Burr King grinders are known for.
- The design of this grinder allows for grinding at multiple points: contact wheel, slack belt, and platen grinding.
- Precision machined components
- Belt changes are made quickly and easily
- Belt Speed: 8,000 feet per minute
- Perfect angles can be achieved thanks to the included adjustable work rest.
- 1 year manufacturer's warranty
- Made in the U.S.A.



X400



X400-BK Belt Grinder (2" x 48" belt, 1hp, 110v) SALE! \$1,702.40
X400-BK Belt Grinder Deluxe Kit (includes: belt grinder, floor pedestal, and 10 piece belt kit) SALE! \$2,191.99

BURR KING BELT GRINDERS

Finance as low as \$50.00 / Month

482



- These popular 3-wheel grinders feature slack contour belt grinding as well as contact wheel and work rest grinding.
- Standard units are wired for 110v
- Precision machined components
- Smooth and powerful operation
- Quick belt change & tracking
- Best quality and widest range of options available
- 1 year manufacturer's warranty
- Made in the U.S.A.

482-BK, 482 Belt Grinder (2" x 48" belt, 110v) SALE! \$2,131.80
760-150-VS, 760 Variable Speed Belt Grinder (800-8000 SFPM, 1-1/2" x 60" belt, 110v) SALE! \$3,300.30

KALAMAZOO COMBINATION GRINDER

Finance as low as \$66.00 / Month

- This industrial duty combination belt and disc sander features a 3 hp motor and optional vacuum base.
- Belt changes are fast and easy with a single tension lever release.
- Useful in education, knife making, automotive, foundries, and other manufacturing environments
- Belt sanding head can be positioned vertically or horizontally
- **Belt Size:** 6" x 48"
- **Disc Size:** 12"
- **Belt Speed:** 2800 sfpm
- **Table Size:** 6" x 10"
- 1 year manufacturer's warranty
- Made in the U.S.A.



Kalamazoo Combination Belt and Disc Sander (6" x 48" belt, 220v 1ph, add \$200 for vacuum base) . . . \$2,695.00

KALAMAZOO 20" DISC GRINDER

Finance as low as \$78.00 / Month



- The 20" Kalamazoo Disc Grinder is constructed using a rugged cast iron base, heavy duty column, cast iron table, and a balanced steel disc.
- The reversible disc turns at 1740 rpm and is available in a 1.5 hp 1ph, or 2hp 3ph Baldor motor.
- Table tilts 45 degrees out and can be raised or lowered up to 6 inches for maximum disc use.
- Kalamazoo utilizes PSA adhesive sanding discs ideal for profiling with steel, aluminum or wood.
- Table Size: 10.5 x 27 inch
- Disc Speed: 1740 rpm
- 1 year manufacturer's warranty



Kalamazoo 20 inch Disc Grinder \$3,175.00

BURR KING VIBRATORY BOWLS

3 quart

10 quart

20 quart



- Vibratory Bowls provide an efficient and effortless way to descale, clean, polish, and remove rust from metal parts.
- Vibra-King machines feature small to large capacities ranging from benchtop bowls to floor standing chamber units.
- Media kits of many kinds are available for the proper treatment.

3 quart Benchtop Vibratory Bowl (110v, 1 ph)..... \$483.00
 10 quart Benchtop Vibratory Bowl (110v, 1 ph)..... \$946.00
 20 quart Benchtop Vibratory Bowl (110v, 1 ph)..... \$1,144.00

525 INDUSTRIES

360 DEGREE TUBING SANDER



- The 360 degree Tubing Sander Attachment fits most standard 1/4 inch collet die grinders.
- Ideal for removing mill scale, finishing, and sanding round tubing and especially useful for weld prep on tubular chassis for race cars, motorcycles, and off-road vehicles.
- This lightweight tool easily operates with one hand and changes belts in seconds.
- Works on tubing from 3/4 inch through 2 inch OD
- Die Grinder not included
- Made in the USA



525 Industries 360 degree Tubing Sander Attachment (Die Grinder not included) \$489.00

3M

AIR BELT FILE



- 3M belt file uses 3M Abrasive Belts for a variety of metalworking applications.
- Popular for use in collision repair for grinding through spot welds in high strength steel.
- Uses belt widths from 1/8 inch up to 3/4 inch and 18-24 inch lengths with optional arms.



3M Abrasive File Belt Sander **SALE!** \$820.12

BEVELER USA

AIR DEBURRING SYSTEM

- The B2-AIR is a compact, lightweight, and ergonomic deburring solution for plate steel.
- The perfect tool for deburring and finishing plasma, laser, or waterjet cut parts.
- Includes blades for 45 degree angles and rounding blades are available for radiused edges
- Quick-Adjust depth stop features large, easy to read increments for precise depth adjustment
- Motor: Pneumatic • Speed: 23,000 RPM • Air Consumption: 11.3 CFM (320 l/min)
- Bevel Width Max: 2mm • Rounding Radius: 1.5mm



B2-AIR Deburring System \$577.00

FEIN

PIPE POLISHERS



Finance as low as \$50.00 / Month

- Works with all types of ferrous and non-ferrous metals
- Perfect tool to remove weld seams, sand scratches, and polish to a satin or mirror finish.
- Popular in the stainless handrail industry
- Quick belt change & tracking adjustments
- **Motor:** 750 Watt Output
RPM: 2,700-7,000
- **Belt width:** 1-9/16 inch and 13/16 inch
- **Belt Speed:** 72 ft/sec

RS 10-70E Pipe Polisher Kit **SALE!** \$1,439.00
 RS 12-70E Professional Pipe Polisher Kit (shown) **SALE!** \$2,019.00

GRINDING & SANDING

EDWARDS IRONWORKERS

Established in 1875, Edwards Manufacturing builds ironworkers that are both rugged and dependable. Their vertical slide movement keeps punches and accessory tools aligned properly through the full range of stroke. A wide range of workstations are available to streamline your production needs and expand your production capabilities. Edwards also offers PowerLink Accessories including tubing benders, h-frame presses, and a horizontal press to further maximize your machines capabilities and take your manufacturing to the next level. See the newly revised line of quality USA Made ironworkers and accessories here.



Jaws 55 Ton

Capacities	IW50 ton	IW55 ton	IW65 ton	IW75 ton	IW100 ton
Punch	1" - 5/8"	1-1/16" - 5/8"	1-1/16" - 3/4"	1-1/16" - 7/8"	1-1/16" - 1"
Plate Shear	1/2" x 10"	3/8" x 14"	3/8" x 24"	1/2" x 14"	3/4" x 14"
Angle Shear	4" x 1/4"	4" x 1/4"	5" x 3/8"	5" x 3/8"	6" x 1/2"

- Jaws 50 ton (230v 5 hp 3 ph, add \$650 for 1 ph) **SALE!** \$13,999.00
- Jaws 55 ton (230v 5 hp 3 ph, add \$630 for 1 ph) **SALE!** \$14,859.00
- Jaws 65 ton (230v 7.5 hp 3 ph, add \$500 for 1 ph) **SALE!** \$27,299.00
- Jaws 75 ton (230v 7.5 hp 3 ph, add \$570 for 1 ph) **SALE!** \$26,399.00
- Jaws 100 ton (230v 7.5 hp 3 ph, add \$630 for 1 ph) **SALE!** \$31,299.00
- PowerLink Hydraulic Accessory Pack up to 60 ton (Required for use of accessories) \$1,690.00
- PowerLink Hydraulic Accessory Pack 65 ton and up (Required for use of accessories) . . . \$1,700.00

ACCESSORIES



20 Ton

- Utilizes the hydraulic system on Edwards Ironworkers
- Hydraulic accessory port option required for use of accessories
- The 20 ton Horizontal Press makes short work of a variety of complex metal forming operations.

- H-Frame Press Benchtop Accessory, 20 ton **SALE!** \$4,249.00
- H-Frame Press Accessory, 40 ton **SALE!** \$8,489.00
- 12" Press Brake Tooling for 20 ton H-Frame Press **SALE!** \$2,129.00
- 32" Press Brake Tooling for 40 ton H-Frame Press **SALE!** \$4,669.00
- HAT6000 Horizontal Press Accessory, 20 ton \$11,779.00

HAT6000



- Electric/hydraulic Porta Power allows the use of Edwards accessories without the requirement of an Ironworker.
- Tube Bender Accessory has a 2-1/2 inch x .095 capacity

- Hydraulic Tubing Bender Accessory **SALE!** \$4,249.00
- Roll Bending Accessory **SALE!** \$10,399.00
- Electric/hydraulic Porta Power, 3,000 psi **SALE!** \$4,989.00



TRICK-TOOLS PORTABLE PUNCH



- The 35-Ton Porta-Punch weighs just 31 pounds, is easy to use, and punches in seconds.
- The dual-action stripper holds and strips the material being punched.
- Ideal for punching bus bars, tower iron, railing, I-beams and truck frames
- The included pump has a 1 hp, 115 volt motor delivering 10,000 psi and includes a 10 ft hose with quick disconnects for fast set up and tear down.
- Mount to your work bench or take it to the job site.

- Hydraulic Portable Punching Unit, 35 ton \$3,750.00

SCOTCHMAN IRONWORKERS

Finance as low as
\$166.00 / Month

5014-ET 50 Ton



- This 50 ton Ironworker provides incredible shearing, punching, and notching capabilities.
- Comes standard with seven stations including a punching station, angle and bar shears, and a rectangular coping station.
- This Ironworker features a unique punching station with a 3-station revolving turret.

5014-ET 50 ton (220v 3 hp 3 ph, add \$300 for 1 ph)\$15,490.00



Porta-Fab 45 Ton

Capacities	Porta-Fab 25 ton	5014-TM 50 ton	6509-24M 65 ton	9012-24M 90 ton	12014-24M 100 ton
Punch	1-1/8" - 1/2"	1" - 5/8"	1-1/16" - 5/8"	1-1/16" - 3/4"	1-1/16" - 1"
Plate Shear	1/2" x 4"	1/2" x 10"	3/8" x 14"	3/8" x 24"	3/4" x 14"
Angle Shear	3" x 5/16"	4" x 1/4"	4" x 1/4"	5" x 3/8"	6" x 1/2"

- Porta-Fab 45 ton (110v 2 hp, add \$900 for 220v 1ph)\$7,640.00
- 50514-EC 50 ton (220v 5 hp 3 ph, add \$300 for 1 ph)\$13,190.00
- 6509-24M 65 ton (220v 5 hp 3 ph, add \$300 for 1 ph)\$19,690.00
- 9012-24M 90 ton (220v 5 hp 3 ph, add \$300 for 1 ph)\$22,890.00
- 12012-24M 120 ton (220v 5 hp 3 ph, add \$300 for 1 ph)\$30,090.00

DAKE PRESSES



- These arbor presses are used for everything from simple pressing operations and assembly work to broaching applications.
- Pressing wheel lugs, wheel cylinders, and rebuilding u-joints are just a few of the common uses for these presses.

- Dake No. 00 Single Leverage Arbor Press, 1 ton\$329.46
- Dake No. 1 Single Leverage Arbor Press, 3 ton\$785.00
- Dake No. 1-1/2 Ratchet Leverage Arbor Press, 3 ton\$1,095.00
- Dake No. 3A Ratchet Leverage Arbor Press, 5 ton.....\$3,432.39



H-FRAME PRESSES



B10

- H-Frame Presses allow for substantial pressure with minimal effort.
- We offer shop presses that power the hydraulics with a manual pump or an electric pump, from 10 to 100 ton capacities.
- Great for removing and installing bearings, bushings, pulleys, U-joints and many other pressing applications.

- Dake B10 36" H-Frame Bench Mount Press, 10 ton\$425.00
- Dake 25H Manual H-Frame Press, 25 ton.....\$3,635.00
- Dake 75H Manual H-Frame Press, 75 ton.....\$5,920.00
- Dake Force 10DA Powered H-Frame Press, 10 ton (110v)\$3,625.00
- Dake Force 40 Powered H-Frame Press, 40 ton (220/440v, 3 ph) ... \$10,475.00
- Dake Force 100 Powered H-Frame Press, 100 ton (220/440v, 3 ph) ..\$15,775.00



IRONWORKERS & PRESSES



QUALITY TOOLS BACKED BY OUR NO JUNK GUARANTEE

MITTLER BROS PUNCH & FLARES



- Mittler Bros. Punch & Flare tools can create a smooth hole, with or without a flare in one easy step.
- Drill a pilot hole for the draw bolt, then apply the tool and tighten the bolt.
- Works great in our Mittler Bros. Bench Press with no drilling needed.
- 16 gauge mild steel maximum

1", 1-1/4", 1-1/2", 1-3/4", 2", 2-1/2", 2-5/8", 3" Individual Sizes Starting at \$120.00 ea.
 1300-402 6 Piece Punch & Flare Set (1" to 2-1/2") \$720.00
 1300-403 7 Piece Punch & Flare Set (1" to 3", 2-5/8" not included) \$860.00

MITTLER BROS FLARE TOOLS



- Flare an existing hole in sheet metal panels for improved strength and appearance.
- Use in a Mittler Bros. bench press or by simply using the draw bolt and a standard wrench.
- 16 gauge steel is the maximum thickness.

1/2", 5/8", 3/4", 1", 1-1/4", 1-1/2", 1-3/4", 2", 2-1/2" Individual Sizes Starting at \$47.00 ea.
 1300-401 9 Piece Flare Tool Set (1/2" to 2-1/2") \$370.00

MITTLER BROS PUNCH & BEAD TOOLS



- Our Punch & Bead tools can create a smooth hole, with or without a bead in one easy step.
- Simply drill a pilot hole for the draw bolt, then apply the tool and tighten the bolt.
- Works great in our Bench Press with no drilling needed for even faster production.
- 19 gauge steel maximum

1", 1-1/4", 1-1/2", 1-3/4", 2", 2-1/2", 3" Individual Sizes Starting at \$120.00 ea.
 1300-402-B 6 Piece Punch & Bead Set (1", 1-1/4", 1-1/2", 1-3/4", 2" and 2-1/2") \$720.00
 1300-403-B 7 Piece Punch & Bead Set (1", 1-1/4", 1-1/2", 1-3/4", 2", 2-1/2" and 3") \$860.00

MITTLER BROS DIMPLE DIES



- Mittler Bros Dimple Dies are used to improve the strength and appearance of a panel.
- Will flange or flare an existing hole in sheet metal up to .125" 4130 chrome moly
- Each size is self centering, so they work great in a press or ironworker
- Precision machined from hardened tool steel for years of use

1310-314 9 Piece Dimple Die Set (1/2", 3/4", 1", 1-1/4", 1-1/2", 1-3/4", 2", 2-1/2", and 3") \$940.00
 1310-313 7 Piece Dimple Die Set (1/2", 3/4", 1", 1-1/4", 1-1/2", 1-3/4", and 2") \$545.00
 1310-311 5 Piece Dimple Die Set (1/2", 1", 1-1/2", 2", and 2-1/2") \$555.00
 1310-310 4 Piece Dimple Die Set (1/2", 1", 1-1/2", and 2") \$370.00

JAMEY JORDAN SERIES PUNCH & FLARES



- Create unique shaped holes with or without a flare
- Simply drill three pilot holes with included template, and place the tooling and material in a press!



Oval Punch & Flare 3 Piece Set (16 ga steel, .060" aluminum) \$1,465.00
 Triangle Punch & Flare 3 Piece Set (16 ga steel, .060" aluminum) \$1,465.00
 See website for individual sizes

IRONWORKERS & PRESSES

BEND PRESS

BENCHTOP PRESS BRAKE

- Perfect solution for needing to bend small sections of sheet metal and plate steel.
- Its small footprint makes this press a perfect fit for those with limited working space.
- With the optional 4-sided V-die made from 4140 tool steel, tight radius bends can be made in lighter weight materials.
- Uses common 20 ton bottle jack and requires no outside power source
- Ideal for making suspension and body support brackets
- Bottle Jack not included



Scan for Video



Material Length	10"	9"	8"	4"	2"
Capacity (Steel)	1/4"	5/16"	3/8"	1/2"	5/8"

Benchtop Press Brake \$529.95
 4-way V-die (1/2", 3/4", 1" and 1-1/2" openings). \$219.95

SWAG OFFROAD

FINGER BRAKE



- A perfect addition to the 20 ton press found in many home workshops or garages.
- Segmented fingers in the top bar can be removed or rearranged to allow bending of restricted areas or on parts that have other bends in them.
- Fingers are segmented in 1, 2, 3, 4, and 9.5 inch pieces with a maximum bending length of 19.25 inches.

STANDARD DUTY CAPACITIES

- 19" in 1/8" mild steel
- 15" in 3/16" mild steel
- 12" in 1/4" mild steel
- 5" in 3/8" mild steel
- 2" in 5/8" mild steel

HEAVY DUTY CAPACITIES

- 19" in 3/16" mild steel
- 13" in 5/16" mild steel
- 11" in 3/8" mild steel
- 6" in 1/2" mild steel
- 3" in 5/8" mild steel

Swag Offroad Standard Duty Finger Brake \$429.95
 Swag Offroad Heavy Duty Finger Brake \$499.95

ATEK

PRESS BRAKES



Finance as low as \$223.00 / Month

- Atek Press Brakes are pneumatically powered and are available in 2 ft through 10 ft models, with tonnage ratings of 12, 24 and 42 tons.
- They perform numerous prototyping and production press brake functions including bending, hemming, box forming, and more.
- Additional features include adjustable stroke depth control, adjustable die spacing, tamper proof speed control valve, OSHA lockout, and a variable tonnage control.

B424



B412 4 ft Press Brake, 12 ton \$8,993.00
 B424 4 ft Press Brake, 24 ton \$15,828.00
 PM442 4 ft Press Brake, 42 ton \$23,268.00
 B824 8 ft Press Brake, 24 ton \$24,360.00
 PM842 8 ft Press Brake, 42 ton \$28,895.00

BAILEIGH

42 TON PRESS BRAKE



Finance as low as \$549.00 / Month

- This Baileigh Industrial press brake is great for shops of any size.
- Operates on 110 volt power and features a large 42 ton capacity.
- Hands free foot pedal operation and digital read-outs ensure safety and repeatability.
- Includes Multi-Vee bottom die and upper punch
- Handles bump die tooling with its 2 inch stroke and large 7-3/4 inch open height.
- Mild Steel Capacity: 1/4 inch

Baileigh Hydraulic Press Brake, 42 ton **SALE!** \$24,159.00

METALACE BULLSEYE PICKS

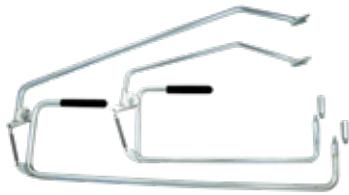

- Metal Finishing: Bullseye picks make it easy to accurately repair dents like a professional.
- Return Spring: Allows you to hit quickly, with the advantage of knowing where the pick will strike.
- Designed for use in hard-to-reach areas such as around braces, gussets and other blind areas.

15" Reach Bullseye Pick \$144.95
25" Reach Bullseye Pick \$159.95

TRICK-TOOLS CURVE TEMPLATES

- These curve templates are commonly used for duplicating complicated contours, ensuring a new part is an exact copy of the old.
- Great for long panels such as hoods, roof skins, fenders, airplane wings, and more



37" Curve Template \$49.99
107" Curve Template \$99.99

COVELL HAMMERS AND DOLLIES



- Covell Signature Line Body Hammers and Dolly Blocks are high quality and made in the USA.
- These products were specified by master metalworker Ron Covell and are his favorite designs from over 50 years of metal shaping experience.
- Hammer heads are drop forged from high carbon steel, heat treated, tempered and polished
- The octagonal hickory wooden handles give a well-balanced, substantial feel with excellent grip capabilities.
- They are built to last for years to come in the most demanding environments.

Covell Body Hammer Starting at \$33.06 ea.
Body Hammer and Dolly Set (Includes 5 Body Hammers and 5 Dolly Blocks) **SALE!** \$329.95

COVELL SLAP HAMMER

- This unique tool is designed by, and is the preferred method, of master metal shaper Ron Covell for smoothing lumpy metal.
- Perfect for metal finishing steel and aluminum and will leave less marking than traditional hammers.
- The high-density foam grip makes it comfortable to use for extended periods.



350-CVL Covell Slap Hammer \$120.00

COVELL ROUND OVER DIES



- Covell Rounding-Over Dies are great for creating a rounded or radiused edge on sheet metal panels.
- Precision machined from heat treated steel, these dies can handle up to 16 gauge mild steel.
- The built-in back stop allows for a smooth and consistent rolled edge, perfect for building tanks and fenders or simply finishing the edge of a part.



5/16", 1/2", 1", and 1-1/2" dies (designed for Pexto 622, adapter sleeves available) \$90.00 ea.
300-CVL Complete Set (designed for Pexto 622, adapter sleeves available) \$339.00
5/16", 1/2", 1", and 1-1/2" Mittler Style Dies (designed for use with Mittler Bros Bead Rollers) ... \$105.00 ea.
400-CVL Complete Mittler Style Set (designed for use with Mittler Bros Bead Rollers) \$399.00

Mittler Style Set

TRUSTY-COOK BOSSING MALLETS



- These dead blow bossing mallets become a favorite for rough-shaping sheet metal before wheeling or planishing.
- Each hammer features an ideal profile for metal shaping, a steel rod handle, and a shot canister encased in a hot cast urethane that resists chipping and marking of the surface.

TCBM1 Dead Blow Bossing Mallet, Small	\$43.00
TCBM2 Dead Blow Bossing Mallet, Medium	\$48.00
TCBM3 Dead Blow Bossing Mallet, Large	\$58.00
TCBM-Kit Dead Blow Bossing Mallet Kit (includes three listed above)	SALE!	\$126.00

METALACE MALLETS & SHOT BAGS

- These high quality bossing mallets are made from a non-marring plastic and are offered in several sizes so you can select a hammer perfectly suited for the job at hand.
- Our selection of shot bags, or sand bags, are made in the USA using a high quality leather and can be filled with #9 lead shot or silica sand.

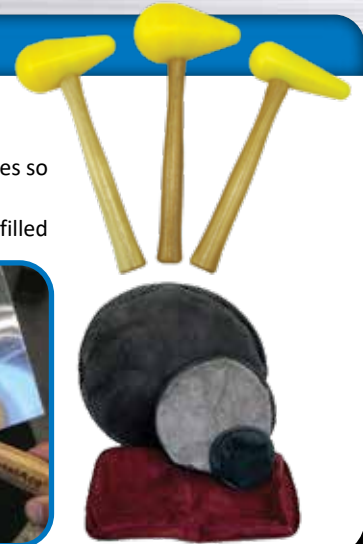

Small Bossing Mallet (right)	\$46.00
Medium Bossing Mallet (left)	\$50.00
Large Bossing Mallet (middle)	\$60.00
Bossing Mallet Kit (includes three listed above)	SALE!	\$148.00
6" Round Shot Bag	\$26.00
12" Round Shot Bag	\$50.00
18" Round Shot Bag	\$63.00
18" Rectangle Shot Bag	\$65.00



METALACE T-DOLLIES

- Tapered and Straight T-Dollies allow for a variety of custom shapes to be created with consistency.
- Clamp in a vice, or in a metal shaping station to form flanges and edges by hammering with slapper or hammer.

FACE DIMENSIONS

- | | |
|---------------------------------------|--|
| • Small Straight T-Dolly: 4" x 0.50" | • Small Tapered T-Dolly: 5.5" x 1" |
| • Medium Straight T-Dolly: 6" x 0.75" | • Medium Tapered T-Dolly: 8.25" x 1.5" |
| • Large Straight T-Dolly: 8" x 1.00" | • Large Tapered T-Dolly: 11" x 2" |

Small T-Dolly	\$37.00	Small Tapered Dolly	\$80.00
Medium T-Dolly	\$44.00	Medium Tapered Dolly	\$100.00
Large T-Dolly	\$50.00	Large Tapered Dolly	\$120.00



PROLINE METAL SHAPING STATION

- This ProLine metal shaping station is built for the professional metal shaper with the ultimate quality in mind.
- The powder coated base and stand are 29 inches tall for a comfortable working height once a tool is installed.
- The deluxe model features a nickel plated tool rack to keep things close at hand as well as an angle adapter for 90 and 45 degree mounting.
- Choose from standard or extended height

ProLine Metal Shaping Station (includes stand, tool rack, and 3 tooling adapters)	\$1,295.00
ProLine Deluxe Metal Shaping Station	SALE!	\$2,195.00
(includes stand, tool rack, angle adapter, 3 tooling adapters, barrel mallet, 3 bossing mallets, 12" shot bag and plate, set of straight T-dollies, radius gauge)		



Finance as low as \$49.00 / Month

LANCASTER

SHRINKER/STRETCHER

- These shrinker/stretcher tools can form curves down to a 3 inch radius in a variety of metals.
- Perfect for forming complicated patch pieces for such areas as rear wheel arches, dog legs, window edges, and trunk edges.
- These hand operated units are made in the U.S.A. by Lancaster.

Shrinker Unit Only	\$220.00
Stretcher Unit Only	\$220.00
Combo Unit (1 body with both sets of jaws)	\$330.00
Combo Unit #2 (both bodies and jaws) SALE!	\$425.00
Replacement Jaws Sets (shrinker or stretcher)	\$130.00



METALACE

SHRINKER/STRETCHER



- Hands free operation allows for better control and feel for your metal work with much faster results.
- Features casters for easy transport around the shop
- Features a working height of 47-1/2 inches and a mild steel capacity of 18 ga.
- Heavy duty return spring means quick action and long life
- Fabricated of heavy wall steel tubing for durability
- 1 year manufacturer's warranty
- Made in the U.S.A.



Shrinker/Stretcher Deluxe Kit (as shown)	\$889.00
Stand Only	\$449.00
SS-DS Covell Shrinker/Stretcher Depth Stop Accessory	\$69.95

JS TOOLS

SHRINKER/STRETCHER

Finance as low as \$79.00 / Month



Scan for Video

- With a 6 inch throat depth, it makes forming compound panels quick and easy
- Shrinker and stretcher jaws swap out in seconds with the included Allen wrench
- Wheel it around the shop and use anywhere because of the included wheeled base
- The KSM155 can form up to 16 ga. mild steel
- High quality Swedish import
- 1 year warranty



KSM 155 Pro Shrinker/Stretcher (includes steel shrinker and stretcher jaws)	\$3,195.00
KSM 003 Shrinker Jaws for Aluminum	\$550.00
KSM 004 Stretcher Jaws for Aluminum	\$550.00
SS-DS-KSM Covell Shrinker/Stretcher Depth Stop Accessory	\$69.95

BAILEIGH

SHRINKER/STRETCHER

Finance as low as \$114.00 / Month

- The Baileigh MSS-14H and MSS-14F are the most heavy duty shrinker/stretchers in our line-up.
- Features a 7 inch throat depth, 14 gauge mild steel, and 12 gauge aluminum capacity.
- Foot pedal operation, leaving hands free to guide the work piece.
- Ultra heavy duty construction
- Made in the USA

MSS-14F

MSS-14F Manual Shrinker/Stretcher	\$4,609.00
MSS-14H Power Shrinker/Stretcher (110v hydraulic pump)	\$6,779.00



METALACE

22B ENGLISH WHEEL

Finance as low as \$37.00 / Month

- Provides outstanding performance on small jobs like motorcycle tanks, tank covers, seat cowls, and aircraft fillets.
- Use on a bench, clamp in a vise, or use with optional welded stand.
- Capacity of 18 ga. steel and .090 inch soft aluminum
- Throat: 22 inches
- Weight: 80 lbs.
- Anvil yoke has an adjustable axle support so the anvil wheel can be trued to the upper wheel
- Standard working height (from bench): 16-1/2 inches
- Standard working height (with opt stand): 45 inches
- Upper wheel: 8 inch dia. x 2 inch wide 1045 alloy steel billet polished to a high surface finish
- 3.25 inch radius anvil wheel standard
- Made in the U.S.A.



22B Benchtop English Wheel (includes 3.25" R anvil wheel)	\$875.00
Discovery Kit (includes 22B, 8.50" R, 3.25" R and flat anvil wheels, plus shot bag, mallet, radius gauge and instruction DVD)	\$1,195.00
22B Deluxe English Wheel (includes floor stand with die rack, 1.0", 2.50", 3.25", 5.0", 8.50" radii and flat anvils)	\$1,655.00
22B Floor Stand (with die rack)	\$230.00

METAL SHAPING

METALACE

30F ENGLISH WHEEL

Finance as low as \$94.00 / Month



- The Metal Ace 30F English Wheel offers metal shaping capabilities for racing, auto restoration, and aircraft rebuilding needs.
- Has enough muscle to form up to 12 gauge steel
- The retractable handle and casters allow for easy portability
- The 3-leg stance gives a solid base on all floors and utilizes a front-mounted rubber pad for stability.
- Anvil yoke is adjustable on both sides of the axle support so the anvil can be trued to the upper wheel
- Features can be rolled into the center of a 60 inch panel
- Quick release cam on lower anvil
- Includes anvil wheel storage rack
- Upper wheel: 8 inch dia. x 3 inch wide 4140HT alloy steel billet, polished to a high surface finish
- Height: 73" • Width: 40" • Throat: 30" • Weight: approx. 340 lbs.
- Made in the U.S.A.



MA30F

30F Assembled English Wheel (includes 2.5", 3.75", 6.0", 12.0", 24.0" radii and flat anvil wheels)	\$3,495.00
Covell Signature Line 30F English Wheel (includes 2.5", 3.75", 6.0", 12.0", 24.0" radii and flat anvil wheels)	\$4,175.00

METALACE

44F ENGLISH WHEEL

Finance as low as \$79.00 / Month

- The Metal Ace 44F English Wheel offers metal shaping capabilities for racing, auto restoration, and aircraft rebuilding needs.
- Capacity of 16 gauge steel and 1/8 inch soft aluminum
- Anvil yoke is adjustable on both sides of the axle support, so the anvil can be trued to the upper wheel
- Features can be rolled into the center of an 88 inch panel
- Quick release cam on lower anvil
- Includes anvil wheel storage rack
- Upper wheel: 8 inch dia. x 3 inch wide 4140HT alloy steel billet, polished to a high surface finish
- Height: 73" • Width: 59" • Throat: 44" • Weight: approx. 350 lbs.
- Made in the U.S.A.



44F Assembled English Wheel (includes 2.5", 3.75", 6.0", 12.0", 24.0" radii and flat anvil wheels)	\$3,495.00
44F U-Weld English Wheel Kit	\$1,929.00

METALACE IMPERIAL 28F



Finance as low as \$106.00 / Month

- Constructed of cast iron and featuring a generous 28 inch throat, the MetalAce 28F Imperial English Wheel works for body panels, motorcycle fenders, aircraft parts and more!
- This tough, small-frame English Wheel provides metal shaping capabilities for any contour, any job.
- Capacity of 16 gauge steel and 1/8 inch soft aluminum

- Throat: 28 inches
- Quick release cam on lower anvil
- Anvil yoke is adjustable on both sides of the axle support so the anvil can be trued to the upper wheel.
- Standard working height: 48.5 inches
- Upper wheel: 8 inch dia. x 3 inch wide 4140HT steel polished to a high surface finish
- Made in the U.S.A.



Imperial 28F English Wheel \$4,295.00
(includes 2" wide, 1.00", 2.50", 3.25", 5.0", 8.50" and flat radius, anvil wheels)

METALACE IMPERIAL 44F

Finance as low as \$248.00 / Month

- Constructed with a massive cast iron frame and featuring an immense 44 inch throat, the 44F Imperial is the toughest English Wheel you can buy.
- Capacity of 16 gauge steel and 3/16 inch soft aluminum
- Throat: 44 inches
- Quick release cam on lower anvil
- Anvil yoke is adjustable on both sides of the axle support so the anvil can be trued to the upper wheel.

- Weight: approx. 1,850 lbs.
- Standard working height: 48.5 inches
- Upper wheel: 8 inch dia. x 3 inch wide 4140HT steel polished to a high surface finish
- Rigid cast iron frame provides a sturdy, vibration-free platform for your job
- Screw lift and upper anvil wheel rotate 90 degrees for larger panels
- Made in the U.S.A.



Imperial 44F English Wheel \$9,995.00
(includes 3" wide, 2.50", 3.75", 6.0", 12.0", 24.0" and flat radius, anvil wheels)

METAL SHAPING

PROLINE PLANISHING HAMMERS



Finance as low as \$124.00 / Month

- Designed for forming or planishing compound curves in sheet metal.
- Used in many industries including automobile and aircraft restoration, and race car fabrication
- An air control valve allows for fine tuning of power output and an automatic air cutoff switch shuts air off to the motor when the foot pedal is up.
- Includes upper die and 3, 12, and 36 inch radii bottom dies
- Uses CP style tooling
- These hammers are built with uncompromised quality and are completely made in the USA.



22" Portable Planishing Hammer \$4,995.00
24" Cast Iron Floor Model Planishing Hammer \$8,500.00
36" Cast Iron Floor Model Planishing Hammer \$12,500.00

PROLINE HAND HELD HAMMERS

- Excellent for auto body work without taking the panel off the vehicle.
- Can be used with or without the yokes.
- Uses CP style tooling

- Includes upper die and 3 lower radius dies: 3R, 12R, and 36R
- Can save hours of time versus traditional hammer and dolly forming.

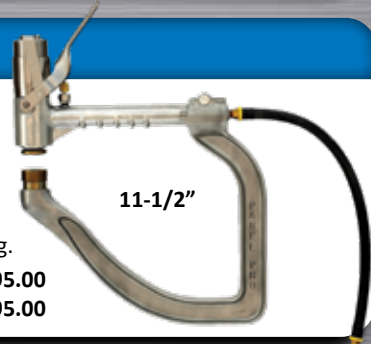

ProLine Hand-Held Cast Aluminum Planishing Hammer (11-1/2 inch throat) \$2,995.00
ProLine Hand-Held Tubular Yoke Planishing Hammer (22-3/4 inch throat) \$2,995.00



QUALITY TOOLS BACKED BY OUR NO JUNK GUARANTEE

MECHAMMER PLANISHING HAMMER



- Mechammer calls it their 'set it and forget it' machine, implying once the machine is set up, it doesn't require constant adjustment for varying material or thickness.
- The unique electric motor and clutch drive system allow for extreme control of power for shaping consistency
- Unlike other traditional planishers, the dies do not clamp the material and gives the operator ultimate control when maneuvering the panel. The dies simply rest on the material while a mechanical interchangeable piston alternately creates positive and negative pressure that moves a pneumatic ram.
- Cushioned hammer blows are automatically adjusted for the thickness of material
- The interchangeable pistons can be exchanged for heavier or lighter impact on the material and an aluminum piston is available for aluminum work.
- Second arm is used for additional clearance below the bottom die when working with tight radius panels
- Die sets are available for a variety of tasks such as planishing, beading, shaping, flanging and tipping. Other specialty anvils are offered as well
 - Variable speed up to 3000 bpm
 - Mild steel capacity: 16 gauge
 - 110v electric motor
 - Throat Height: 22 inches
 - Throat Depth: 20 inches
 - Made in the USA



Mechammer Mark II Planishing Hammer (includes 40mm flat upper die, 3R, 12R, and 36R lower dies) \$6,595.00
Mechammer Mark II Planishing Hammer Deluxe Kit (includes every available die set, see website for complete list) **SALE!** . . . \$11,495.00
Hammer Weight Set (includes heavy, light, and x-light weights for different material and thickness) \$200.00
Thumbnail Shrinking Die Set \$495.00
Planishing Die Kit, 14 Piece (completes the set of all standard planishing dies, included sizes listed below) **SALE!** \$923.00
 (Includes two reverse curve upper dies, 5/8, 3/4, 7/8, 1, 1-1/4, 1-1/2, 2, 4, 6, 24, 40 inch radius dies, and flat lower dies)

PROLINE POWER HAMMER



Finance as low as \$223.00 / Month

- The ProLine Mini-Max does the work of a large and expensive Pullmax machine without taking up valuable shop space.
- Accepts 16mm Pullmax style tooling for shrinking, beading, doming, edge setting, planishing, and more.
- Mild steel capacity: 16 gauge
- Variable Speed
- 1,150 strokes per minute
- Foot control allows for dual hand control
- Includes straight and contour fences
- 1 year warranty



Scan for Video

Mini-Max Variable Speed Power Hammer (110v) \$7,500.00
Mini-Max Deluxe Power Hammer (includes rolling stand, thumbnail shrink dies, 110v). \$8,990.00

MITTLER BROS POWER HAMMER



Finance as low as \$245.00 / Month

- This power hammer by Mittler Bros. is built to replicate a 60 lb Yoder Power Hammer.
- The Mittler Power Hammer utilizes a leather strap & leaf spring to support the upper die assembly which provides a cushioned blow similar to a mallet and shot bag only at a rate of 900 blows per minute.
- The upper die stroke is adjustable to compensate for heavier or more delicate work.
- Can perform shrinking, stretching, and shaping in sheet metal with a variety of optional die sets.
- The machine also features quick release adjustment handles and a quick change tooling system.
 - Based on a 60 lb Yoder M2
 - Strokes per Minute: 900
 - Throat Depth: 26 inches
 - Motor: 110v, 1hp



4200-200 Mittler Bros Power Hammer Kit (includes component kit, flat upper die, and your choice of radius bottom die). . . . \$4,065.00
4200-150-VS Mittler Bros Single Head Power Hammer (includes flat upper die and your choice of radius bottom die). \$10,885.00
4200-100 Mittler Bros Dual Head Power Hammer (includes tooling package). \$18,345.00
4200-600 Optional Tooling Package (includes Shrink, Stretch, Soft, and 4, 6, 12, 24 inch Radius Dies) \$3,160.00

ECKOLD PLANISHING HAMMER



- Can be used in car body restoration, body repair, or anywhere metal must be formed into a particular shape.
- Can save hours of time versus traditional hammer and dolly forming.

- (1) GL2 Planishing Hammer
- (2) Planishing Insert
- (7) Stretching Inserts
- (1) Rectangular billet
- (1) Round Billet
- (1) Rectangular Shaft
- (1) Swivel Shaft
- (1) Changing Tool



GL2 Max Planishing Hammer Kit **\$3,386.47**

ECKOLD HANDFORMER



HF100 PA

- The Handformer series speeds up the shaping process, replacing time consuming hammer form work and increasing productivity.
- HF 100 PA machine features a pneumatic drive allowing for greater material control, while the stroke and working pressure is controlled with the foot pedal.
- Optional tooling includes shrinking and stretching jaws as well as tools for punching, notching, and edging.
- Head adjusts from 0-15° for comfortable work height
- Mild steel capacity: 1.5mm steel, 2mm aluminum
- Throat depth: 4 inches



HZ52



HZ52 Handpliers (Jaws sold separately, 1mm steel and 1.5mm aluminum capacity, 2 inch throat depth) **\$1,613.23**
Handformer HF 100 (manually operated) **\$5,750.45**
Handformer HF 100 PA (HF 100 unit with Pneumatic Drive) **\$9,144.19**
Pneumatic Drive Unit Upgrade for HF 100 (unit only) **\$3,761.07**

ECKOLD KRAFTFORMER

KF800



- The Eckold Kraftformer metal forming machines are powerful, reliable, and precision machines built for decades of use and have huge forming capacities!
- These machines can be used multifunctionally, with optional tooling available for shrinking, stretching doming, flattening, planishing, edging, notching, punching, and straightening.
- Finely tune the forming capacity and stroke frequency for both rough forming and precision work.
- The KF 170 PD has a continuous stroke frequency, however it can be switched to a single stroke for precise correcting and adjusting of parts.
- KF-324 and KF-340 heads adjusts from 0-15° for comfortable work height
- KF-470 and KF-675 are servo motor driven machines designed to work with heavy material up to 6 mm (1/4") and feature an electronic display capable of storing programs for repeatable results.
- Tooling sold separately. Machines FOB Switzerland.



KF170PD

Models	KF 170 PD	KF 800	KF 324	KF 340	KF 470	KF 675
Throat Depth	6.7"	31.5"	13.4"	13.4"	18.1"	26.5"
Strokes Per Min.	150 - 250	100 - 180	400	250 - 550	300/600	150 - 600
Stroke Frequency	Single / Cont.	Single / Cont.	Continuous	Continuous	Continuous	Continuous
Max Capacity Steel	2 mm	2 mm	2 mm	3 mm	3 mm	6 mm
Max Capacity Alum.	2 mm	2 mm	2.5 mm	4 mm	4 mm	6 mm

KF170 PD **Starting at \$15,299.93**
Eckold Kraftformer Machines **Call for Pricing**

See our website for a complete list of Eckold Tooling

ROPER-WHITNEY HAND PUNCHES



Scan for Video

XX



- These hand punches by Roper Whitney can save a lot of time over drilling sheet metal and are much more accurate.
- The 5 Jr punch has a standard 1-3/4" throat depth, while the XX has a deep throat configuration to punch up to 3-1/4" from the edge with up to an 1-3/8" flange.
- 1.2 tons of punching power
- XX kit includes: 5/32", 7/32", 9/32", 11/32", 13/32", 15/32", and 17/32" round punch and die
- Optional bench mount base available
- 5 Jr kit includes: 3/32", 1/8", 5/32", 3/16", 7/32", 1/4", and 9/32" punch and die

5 Jr Hand Punch Kit	\$95.00
5 Jr Bench Mounting Base (not included with kit)	\$35.00
XX Hand Punch Kit	\$300.00
XX Bench Mounting Base (not included with kit)	\$47.00

5 Jr

ROPER-WHITNEY MEDIUM DUTY PUNCHES

- These Roper Whitney heavy duty punches are highly portable and will fit any tool chest.
- The leverage design of these tools assures easy linear operation.
 - Two hand linear operation
 - Throat Depth: 1.625"
 - Throat Height: .313"
 - Weight: 17.5 lbs
- No. 7A punch and dies: 1/16" - 7/16"
- No. 8 punch and dies: 1/16" - 1/2"

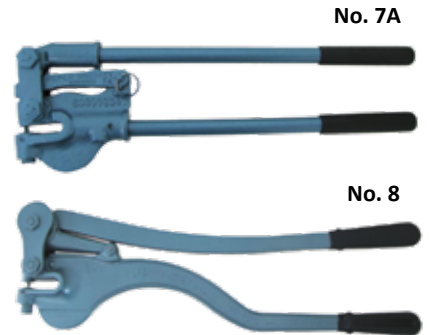

No. 7A

No. 8

No. 7A Punch (two hand linear operation)	\$354.00
No. 8 Punch (5 ton capacity, two hand linear operation)	\$475.00
No. 8 Mounting Base	\$143.00
No. 7A and 8 Punch Dies	\$30.00 ea.

ROPER-WHITNEY BENCH PUNCHES

No. 16



- The Roper Whitney bench punches feature a heavy duty steel frame and are designed to be mounted to a sturdy work bench.
- The No. 16 punch is able to deliver up to 7.3 tons of punching power, while the No. 17 punch is able to generate up to 5 tons of pressure, enough to punch a 1/2 inch hole in 1/8 inch mild steel.
- The die shoe on both tools are adjustable to permit the proper alignment of punches and dies for punching thin sheet metal.

No. 16 Punch (7.3 ton capacity, 3.25" throat depth, 1.75" throat height)	\$595.00
No. 17 Punch (5 ton capacity, 6.5" throat depth, 2.125" throat height)	\$716.00
No. 16 and 17 Punch Dies	Starting at \$46.00 ea.

No. 17



ROPER-WHITNEY ROTARY PUNCHES

- The Roper Whitney rotary style punches produce impressive amounts of punching power.
- The die shoe on both tools are adjustable to permit the proper alignment of punches and dies for punching thin sheet metal.



No. 12



No. 20

No. 10 Punch (7.3 ton capacity, 1.5" throat depth, 1.125" throat height)	\$565.00
No. 10 Mounting Base	\$95.00
No. 12 Punch (7.3 ton capacity, 2.25" throat depth, 2.125" throat height)	\$600.00
No. 12 Mounting Base	\$95.00
No. 20 Punch (20 ton capacity, 2.25" throat depth, 1.625" throat height)	\$636.00



No. 10

HOUGEN

SHEET METAL CUTTERS



- Hougen sheet metal cutters easily outperform standard hole saws by cutting a more accurate hole up to three times faster with far superior tool life.
- These precision ground, heat treated cutters can be used in a hand drill or drill press and will leave a smooth finish with minimal material deformation.
- All sizes can drill up to 1/8 inch thick material and have a "shoulder" to prevent plunge-through.
- Made in the U.S.A



Individual Holcutter Sizes (sizes range from 11/16" - 3") Starting at: **\$15.40**
14005 Holcutter Kit (includes 7/8", 1-1/8", 1-3/8", 1-3/4", 2" and 2-1/2" w/ arbor, pilot pins, and carrying case) **\$174.25**
14005VS Master Fabricator Set (includes 3/4", 1", 1-1/4", 1-1/2", 1-3/4", 2" and 2-1/2" w/ arbor, pilot pins, and carrying case) **\$223.95**

HOUGEN

ROTA-CUT HOLE CUTTERS



- Hougen RotaCut Sheet Metal Cutters utilize the same technology as standard cutters but can be used in 3/8 or 1/2 inch chucks and have a maximum depth of cut of 1/2 inch.
- An optional arbor and lower horsepower requirements make these ideal for use in small mills and drill presses.
- A center punch mark is all that is required to locate and start the spring loaded pilot pin.
- Made in the U.S.A.

RotaCut Sheet Metal Hole Cutters, Individual Sizes (Sizes range from 1/4" - 1-1/2") Starting at: **\$7.95**
11075 RotaCut Kit (1/4" depth, 5/16", 3/8", 7/16", 1/2" 9/16, 5/8", 3/4" w/ arbor assembly, center punch, and extra pilot pin) **\$89.70**
11078 RotaCut Kit (1/2" depth, 7/8", 1", 1-1/8", 1-1/4" 1-3/8, 1-1/2" w/ arbor assembly, center punch, and extra pilot pin) **\$225.00**

DRILLING JIGS AND GUIDES



- These drilling jigs and guides are designed to allow the user to drill precise holes in tubing, pipe, and round stock using a portable electric hand drill and/or drill press.



Cl-1 Center-It Jig (for drill press use, holds round tube and pipe) **\$17.99**
Drill-Rite Guide (portable drill use only, fits pipe dimensions: 3/4" - 2-1/2") **\$69.99**
Tube Drilling Combo (includes Center-It Jig and Drill-Rite Guide) **\$79.99**

FLOWDRILL

FRICTION DRILLING



- Flowdrill exists to provide an inexpensive, high quality replacement for nut-serts or weld-on nuts and bungs when working with thin wall material.
- Flowdrill is a solid tungsten carbide tool, which uses friction to form material into a cylindrical or cone shape.
- This formed hole can then be tapped and used for O2 or EGT sensor installations, brackets and tabs, sheet metal fastening, etc.
- Flowdrill bits can be used in drill presses and milling machines.



Flowdrill Starter Kit #1 (1/4", 5/16") **\$775.00**
Flowdrill Starter Kit #2 (10-32, 1/4", 5/16", 3/8") **\$1,050.00**
Flowdrill Starter Kit for O2 Sensors (Hole Sizes: M18 x 1.5") **\$875.00**
Individual sizes (up to 3/4" OD, Up to 20mm) Starting at **\$76.15**



HOUGEN

LOW PROFILE MAG DRILL

- The HMD130 Low Profile Mag Drill is a lightweight right angle drill with a large capacity for truck frames and general purpose fabrication.
- Features Hougen's RotaLoc mounting system for use with their RotaLoc Plus Cutters which requires no tools for installation or removal
- Other features include a two stage magnet that engages full power only when motor is turned on, high torque gearing, positive slug ejection, lift detector safety system, and rear mounted controls.
- With a height of 6-11/16", the HMD130 will go places where handheld drills, and other mag drills can't.



Model No.	Motor	No. of Speeds	Spindle Speed	Drilling Capacity	Weight	Spindle Travel	Price
HMD130	115V, 9 Amp	1	450 rpm	1-3/8" - 1"	23.8 lbs	2-1/2"	\$1,012.00

TRIUMPH

TWIST DRILLS



- The Thunderbit sets are made in the U.S.A. from high speed steel.
- These bits feature a unique flute design which improves chip ejection and improves coolant flow.
- Each set comes in 1/64th increments ranging from 1/16 - 1/2 inch and feature a 135° split point.
- Thunderbit TiN drill bits have a Titanium Nitride coating for long lasting performance

- Triumph Thunderbit Twist Drill Set, 29 piece (1/16 - 1/2", black & bronze oxide finish) **SALE!** \$126.00
- Triumph Thunderbit Twist Drill Set with 3-Flat Shank, 29 piece (1/16 - 1/2", black & bronze oxide finish) **SALE!** \$126.00
- Triumph Thunderbit Twist Drill Set with 3-Flat Shank, 29 Piece (1/16 - 1/2", black & bronze oxide finish, steel case) **SALE!** \$121.50
- Triumph Thunderbit TiN Coated Twist Drill Set, 29 Piece (1/16 - 1/2", steel case) **SALE!** \$192.15

PUNCHING & DRILLING

ELLIS

9400 DRILL PRESS

Finance as low as \$88.00 / Month



- The Ellis drill press is one of the most versatile drill presses available.
- Comes standard with power down-feed, infinitely variable speed operation, instantaneous reverse for tapping, and a T-slotted table and base; its value is unsurpassed.
- This extremely durable drill press features a 4 inch diameter column, 3 inch diameter quill, and a 2 hp motor.

Spindle Speeds	Drills to Center	Drilling Capacity	Tapping Capacity	Morse Taper	Spindle Travel	Spindle to Table (max.)	Spindle to Base	Table	Base
0-1200 rpm	18-1/8"	Steel: 1-1/16" Cast Iron: 1-1/4"	3/4"	No. 3	5-3/8"	27-1/4"	46-1/4"	15-7/8"	16-3/8" x 26-5/8"

- 9400 Drill Press (110v) **SALE!** \$4,395.00
- Ball Bearing Chuck \$200.00
- Drill Press Vise (6-1/4" Capacity) \$300.00
- Milling Table (11" Crossfeed, 6-1/2" in/out feed) \$400.00

DAKE

DRILL PRESSES

- Dake drill presses are designed for drilling in metal and can be used for a variety of jobs such as tube notching, boring with annular cutters, or forming with our Flowdrill system.
- Variable speed models are powered by a step pulley system or an inverter drive for infinite rpm adjustments.
- The heavy duty column reduces flex while the machined t-slots in the table and base allow for mounting and fixturing for a secure hold on your material.

TB-16V



SB-250V



- TB-16V Bench Model Variable Speed Drill Press (110v, Variable Step Pulley) \$1,835.00
- SB-25V Variable Speed Drill Press (110v, Inverter Drive) \$3,080.00
- SB-32V Variable Speed Drill Press (110v, Inverter Drive) \$3,675.00
- SB-250V Variable Speed Drill Press (220v 3ph, Inverter Drive, Power Down Feed) \$4,199.00

DAKE

CIRCULAR COLD SAWS

Finance as low as \$74.00 / Month

- Head rotates 45 degrees right and left of center for miter cutting and the 350 model rotates to 90 degrees for slotting
- Oversized spindle and gear assembly with steel spindle and bronze gear
- Additional ball bearing support of hardened and ground spindle shaft to prevent failure.
- Cam activated vise with gib adjustment and anti-burr arm
- Reliable mechanical coolant pump with flow control adjustment
- 315 & 350 models feature 24v control circuit, E-stop switch, low voltage and thermal protection, and optional pneumatic vise.
- 350 model features an adjustable pneumatic clutch to eliminate blade breakage.
- All the Dake saws come with a pedestal, blade, tool kit, coolant, adjustable stop, and service manual.
- 1 year manufacturer's warranty

Super Cut 315



Cut 250	10" blade	1.2hp/110v	44 rpm	\$2,995.00
Super Cut 315	12.5" blade	2.5hp, 110v 1ph	44 rpm	\$4,995.00
		2.5hp, 220v 3ph	22/44 rpm	\$4,995.00
Super Technics 350	14" blade	3.5hp, 220/440v 3ph	22/44 rpm	\$6,795.00

Capacity	Round Solid		Round Tube		Square Tube		Rectangle Tube	
	90°	45°	90°	45°	90°	45°	90°	45°
Cut 250	1-1/4"	1"	2-3/4"	2-3/8"	2-1/2"	2-1/8"	3-7/8" x 1-3/4"	2-1/2" x 1-7/8"
Super Cut 315	2-1/8"	1-3/4"	3-5/8"	3-1/2"	3-1/4"	3-1/8"	4-1/4" x 2-3/4"	3-1/4" x 2-3/4"
Super Technics 350	3-3/8"	3"	4-3/4"	4"	4-1/8"	3-3/8"	6-1/4" x 3-1/2"	3-3/8" x 2-3/4"

SCOTCHMAN

CIRCULAR COLD SAWS

Finance as low as \$165.00 / Month

- Scotchman Cold Saws provide clean, straight, burr-free cuts, easy miter cuts, and safe operation without sparks or heat.
- Head rotates 45 degrees right and left for miter cutting
- Slotting operations can be performed with a head that will rotate up to 90 degrees.
- Miter locking pins at 45 degrees left and right provide fast angle selection
- 7 gallon coolant tank with pump
- Emergency stop button is equipped for operator safety.
- These rugged machines are made to last with hardened and ground bronze gears to provide years of trouble-free service.
- PKPD Series features an air-operated clamp for material vise
- PKPD Series utilizes a pneumatic power down feed with electric controls
- PKPD Series uses separate feed controls for rate and pressure
- 3 year manufacturer's warranty



Model	Blade Size	Motor	RPM	Price
CPO 275 CPO 275 PKPD (Semi-Auto)	11"	2.0hp, 220/440v 3ph 1.5hp, 220/440v 3ph	60	CPO 275: \$6,660.00 CPO 275 PKPD: \$10,060.00
CPO 350 CPO 350 PKPD (Semi-Auto)	14"	2.5hp, 220/440v 3ph 3.0hp, 220/440v 3ph 5.0hp, 220/440v 3ph	44	CPO 350: \$7,660.00 CPO 350 PKPD: \$11,060.00

Capacity	Round Solid		Round Tube		Square Tube		Rectangle Tube	
	90°	45°	90°	45°	90°	45°	90°	45°
CPO 275	1-1/2"	1"	3-3/8"	2-3/4"	3"	2-5/8"	3-1/2" x 2-3/8"	2-5/8" x 2-5/8"
CPO 350	2"	1-3/4"	4-7/8"	4-3/8"	4-1/2"	4"	5-1/2" x 4"	4" x 4"
CPO 275 PKPD	1-1/2"	1"	3-3/8"	2-3/4"	3"	2-5/8"	3-1/2" x 2-3/8"	2-5/8" x 2-5/8"
CPO 350 PKPD	2"	1-3/4"	4-7/8"	4-3/8"	4-1/2"	4"	5-1/2" x 4"	4" x 4"

S
A
W
S

EVOLUTION TCT CIRCULAR SAWS

- The Evolution line of saws covers many applications from thin sheet metal to 1/2 inch thick plate!
- Cuts tubing, angle iron, metal grating, channel, roofing, fencing, frames and more.
- Much cleaner, faster, and safer than torches, portabands and other methods.
- The Evolution saw line offers two sizes of machines that are covered by a three-year manufacturer's warranty
 - Clean cutting, collects virtually all chips and sparks
 - Lightweight, only 12 or 20 lbs, depending on model
 - Cutting depth up to 2-1/2" or 3-1/4", depending on model
 - Spindle lock for fast easy blade changes
- Dry cutting for minimal clean up
- Sturdy carrying case
- Overload switch
- Laser guide on EVOSAW230



S185CCSL

S185CCSL TCT Circular Saw (110v 1.4 hp, 7-1/4" blade included) **SALE!** \$165.00
 EVOSAW230 TCT Circular Saw (110v 2.3 hp, 9" blade included) **SALE!** \$299.00

EVOLUTION TCT CHOP SAW

- Evolution saws are much cleaner, faster, and safer than torches, portabands and other methods.
- These saws utilize tungsten carbide tooth blades (TCT blades) for fast and clean steel cutting.
- These saws are more economical than abrasive chop saws due to the long blade life.
- The 110v motor spins at a lower speed and higher torque than traditional abrasive saws.
- Cuts stainless, aluminum, steel, and more
- Vise pivots up to 45° for miter cuts

Model	EVOSAW185	S355CPSL	S380CPS
Blade Size	7-1/4"	14"	15"
Blade Speed (rpm):	3900	1450	1450
Capacity (round)	2" OD	5-1/8" OD	5-1/8" OD
Mitering Range	45 degrees	45 degrees	45 degrees



S380CPS

EVOSAW185HD TCT Chop Saw (110v, 1.6 hp) \$209.00
 S355CPSL TCT Chop Saw (110v, 2.4 hp) \$379.00
 S380CPS TCT Chop Saw (110v, 2.4 hp, accepts 15 inch TCT Blade) .. \$479.00

SAWS

FEIN TCT CIRCULAR SAWS



MCSL09

- The Fein Slugger Metal Cutting Saws cut through almost any type of material effortlessly.
- Lightweight, only 14 or 20 lbs, depending on model
- Cutting depth from 2 or 3-1/4 inches, depending on model
- Overload switch
- Spindle lock for fast easy blade changes
- Features a heavy duty oil bath worm gear drive
- 45 degree beveling ability

MCSL07 Slugger TCT Circular Saw (110v, 7-1/4" blade included) **SALE!** \$245.00
 MCSL09 TCT Circular Saw (110v, 9" blade included) **SALE!** \$325.00
 MCCS14 14" Chop Saw (110v, 2.4hp) **SALE!** \$499.00



Scan for Video

PORTABAND PRO PORTA-BAND JIG

- The Portaband Pro allows you to use your Portaband Saw as a portable chop saw and as an upright bandsaw.
- The adjustable fence allows you to cut a variety of materials from 30 to 90 degree angles.

Portaband Pro for Milwaukee Deep Cut Portable Saws (6232-20, 2729-20 models only) ... \$359.99
 Portaband Pro for DeWalt Portable Band Saws (Model DWM120 only) \$359.99
 Portaband Pro Vertical Table \$49.99
 Portaband Pro Deluxe Kit for Milwaukee Saw (Jig, Vertical Table, and Clamp Accessory) ... \$449.99



HEM SAW

PORTABLE BAND SAW

- Perfect for the hobbyist needing a lightweight portable saw with large cutting capacity
- Two speed control aids cutting both ferrous and non-ferrous metals
- 45 degree swiveling miter head makes miter cuts a breeze
- Features a powerful 1hp, 110v motor
- Adjustable front band guide
- Optional table for vertical use



782XL Portable Band Saw SALE! \$595.00
Vertical Work Table \$144.00

HEM SAW

MITERING HEAD BAND SAW



NG120XL



Finance as low as \$34.00 / Month

- Perfect for the hobbyist needing a lightweight portable saw with large cutting capacity
- Variable speed control aids cutting both ferrous and non-ferrous metals
- Cast construction allows for years of use
- Reverse blade rotation results in up to 60% faster cuts than similar saws of this size
- ABS models feature a unique gravity down feed system that allows for hands free cutting.

Model	Capacity	Blade Size	Speeds (fpm)	Motor	Mitering	Weight	Price
NG120XL	4-3/4" Round	56-3/4" x 1/2"	115-260	1.7 hp 110v	60°	39 lbs.	\$1,555.00
NG160	6" Round	68-3/4" x 1/2"	115-260	2.7 hp 110v	45°	77 lbs.	\$2,295.00
NG120ABS	4-3/4" Round	56-3/4" x 1/4"	98.5-262.5	1.7 hp 110v	60°	39 lbs.	\$1,775.00
NG160ABS	6" Round	68-1/4" x 1/4"	98.5-262.5	2.7 hp, 110v	45°	77 lbs.	\$2,635.00

HEM SAW

MITERING HEAD BAND SAW

- This mitering head band saw is excellent for the industrial user needing accurate cuts and large capacity (6-7/8 inch capacity).
- The heavy duty cast iron and steel construction equates to a very durable cutting platform.
- Coolant system keeps blade and material cool during the cutting process
- Head rotates up to 60 degrees for almost any miter cut and features a hydraulic downfeed control.
- An adjustable length stop is included for repeatable cuts



Finance as low as \$91.00 / Month

Femi 2200DA-XL (110v) \$3,675.00

HEM SAW

CARIF UTILITY BAND SAWS

HEM260BSA



Finance as low as \$210.00 / Month

- Carif Saws are dual mitering, semi-automatic band saws for industrial use.
- Its patented hydraulic system operates the vise, feed rate, and cutting pressure.
- The mitering head rotates 45° in both directions, and 60° to the left.
- Flood Coolant System with 13 gal. tank
- Sealed bearings at Bow pivot point
- Bow height stop for repeatable cutting
- Mobile Control Console
- Parts Counter available on 320BSA model
- Material depth stop.



Model	Capacity	Blade Size	Speeds (sfpm)	Motor	Dimensions	Weight
HEM260BSA	8-3/4" Round	96-1/2" x 1"	106/216	1.4 hp, 220v 3ph	50 x 30 x 60	760 lbs.
HEM320BSA	10-7/8" Round	119" x 1"	49 - 328	3 hp, 440v 3ph	57 x 35 x 71	1500 lbs.

HEMSaw HEM260BSA Carif Band Saw (2 speed, 220v 3ph) \$9,295.00
HEMSaw HEM320BSA Carif Band Saw (2 speed, 220v 3ph, or Variable Speed, 440v 3ph) \$14,115.00



QUALITY TOOLS BACKED BY OUR NO JUNK GUARANTEE

S
A
W
S

DUAL MITERING BAND SAW

Finance as low as \$84.00 / Month

- Ellis Saws feature dual mitering capabilities, extremely large cutting capacity, and rugged durability.
- Head miters up to 50 degrees, both left and right, using the built-in protractor
- Hydraulic control featuring a locking valve controls head feed rate
- Quick acting vise makes clamping and unclamping quick and easy

- Ellis 1600 **SALE!** \$3,495.00
- Ellis 1800 **SALE!** \$4,195.00
- Ellis 2000 \$4,895.00
- Ellis 3000 \$5,295.00
- Ellis 4000 \$6,395.00



Model	Capacity (90°)	Capacity (45°)	Blade Size	Speeds (fpm)	Motor	Dimensions	Weight
1600	10" round, 11" flat	6.875" round, 7.25" flat	120" x 1"	70/135/250	1 hp 110v	59 x 24 x 47	481 lbs.
1800	11" round, 14" flat	9" round, 9" flat	132" x 1"	70/135/250	1 hp 110v	66 x 29 x 47	640 lbs.
2000	11" round, 11" flat	11" round, 9" flat	144" x 1"	70/135/240	1.5 hp 220v	72 x 34 x 47	800 lbs.
3000	13.5" round, 13" flat	12" round, 10" flat	162" x 1"	80/135/220	2 hp 220v	81 x 394 x 50	1000 lbs.
4000	13.5" round, 13" flat	13.5" round, 13" flat	180" x 1.25"	75/135/195	2 hp 220v	81 x 394 x 50	1000 lbs.

ROLL-IN

GRAVITY FEED BAND SAW

Finance as low as \$146.00 / Month

- The EF1459 is a horizontal band saw built on a vertical frame making it a great all-purpose saw.
- Can be used as a cut-off saw, contour saw, and a rip saw, making it ideal for production environments
- The first saw in America to use the patented gravity system
- Vise miters up to 45° • Portable with optional casters

Blade Width	Speeds (fpm)	Motor	Throat Cap.	Work Height	Weight
1/4" - 3/4"	70/140/270/525	1 hp	8-3/4"	30"	650 lbs.

Roll-In EF1459 Gravity Feed Vertical Band Saw \$5,895.00



ROLL-IN

JOURNEYMAN BAND SAW

Finance as low as \$219.00 / Month



- The Journeyman band saws from Roll-In are built for lasting life in fabrication, R&D, and machine shops.
- Saws come standard with a 2hp motor and digital speed control for precise blade speeds.
- The 20 inch throat depth and massive 24 inch precision ground table gives plenty of room for cutting large parts.
- A chip dust blower comes standard to increase blade life and to keep the cutting area free of chips.
- The JM1220 model features an easily adjustable table that tilts up to 45 degrees for specialty cuts and also has a hydraulic feed feature that feeds material into the blade for horizontal saw-like capabilities.
- An optional saw blade welder, grinder, and shear is available.
- Proudly Made in the USA

Blade Width	Blade Length	Speeds (fpm)	Throat Depth
1/4" - 3/4"	154"	70 - 500	37

JE1320 Journeyman Band Saw (stationary table, 220v 1ph) \$8,845.00
 JM1220 Journeyman Band Saw (includes tilting hydraulic feed table, 220v 1ph) ... \$10,875.00



EVOLUTION MAG BRUSH

- Helps pick up filings and chips by the use of a powerful magnet
- Simply pull the plunger out to release over a bin or waste basket
- So handy you'll want one by all your machines!

MCC390 Magnetic Chip Brush (15" length) \$25.00
 MCC1040 Magnetic Chip Brush (40" length) \$75.00



BEND-TECH

TUBE BENDING SOFTWARE

- Bend-Tech offers tube bending software solutions for everyone from the hobbyist to the professional fabricator.
- Using the finished part dimensions, this software calculates how long to cut your tube as well as where to start each bend regardless of your bender type, saving you hours of calculating and reduce wasted material.
- Each version contains several common templates for nearly any application.
- With Bend-Tech SE, users have the option of sketch mode for drawing custom parts as well as X, Y, Z dimensional input.
- You can even view and rotate a three dimensional model of the finished part and watch a simulation of how it will bend on your specific bender.

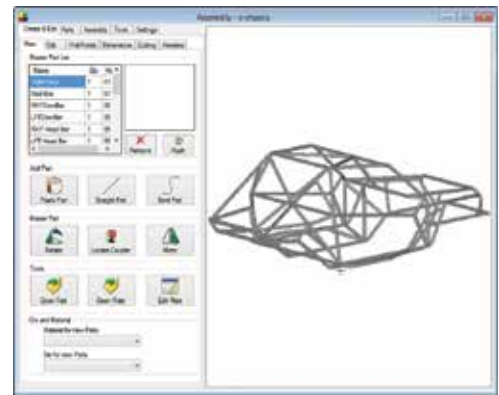
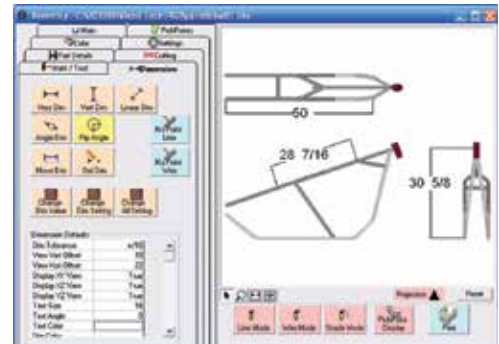

Features	EZ	EZ-3D	PRO	SE
Designer: Templates Designer: Custom Part 2D Material and Die Libraries Basic Calculation Output Post Bending Cutoff	✓	✓	✓	✓
Designer: Custom Part 3D Rotational Calculations Bend Order Manipulation Bending Simulation		✓	✓	✓
Designer: Assembly Design Dimensioning Profile Cutting (fish-mouthing, coping & mitering) Spring Back Calculator			✓	✓
Designer: XYZ Designer: Reverse Engineering STEP & IGES import/export Advanced Calculation Output Unit Conversion Manufacturability Checking Multiple Dies for Single Part Large Radius Bending (including crowning) Extended Tooling Library Definitions Railing Module Output DXF file of cutting profile				✓
Bend Limit (per part)	6	6	10	100

Bend-Tech EZ	\$69.00
Bend-Tech EZ 3D	\$149.00
Bend-Tech Pro	\$295.00
Bend-Tech SE	\$599.00

Optional modules operate inside Bend-Tech Pro and SE programs.

Sheet Metal Module (design sheet metal parts and assemblies) SALE!	\$75.00
Plate Template Module (common motorsports tabs and brackets) SALE!	\$75.00
Header Design Module (design your own exhaust headers) SALE!	\$75.00
Exhaust Design Module (design full exhaust systems around obstructions) SALE!	\$75.00
Roll Cage Templates Module (RCT) (choose from dozens of roll cage designs and set your own dimensions) SALE!	\$75.00
Armor Pack Templates Module (Choose and customize over 100 bumper and rack designs for any application) SALE!	\$125.00
Large Radius Module (LR) (use with Bend-Tech Pro only, create large radius bends) SALE!	\$75.00
Handrail Design Module (use with Bend-Tech SE software only, design handrails around walls and stairs) SALE!	\$300.00
SolidWorks Design Module (use with Bend Tech SE only, import designed tube from SolidWorks directly into Bend-Tech)	\$400.00

TUBE BENDERS



BEND-TECH

PLATE TEMPLATES

- Bend-Tech Plate Templates Motorsports Edition (MSP) is a set of templates designed for the motorsports industry which includes common washers, tabs, gussets, beadlocks, and mounts.
- With customizable dimensioning, you can pick the style of bracket or tab you are looking for and make it the perfect fit for your unique fabrication project.

Bend-Tech Plate Template Software \$295.00

BEND-TECH SHEET METAL SOFTWARE

- Bend-Tech Sheet Metal is used for designing sheet metal parts and assemblies.
- This software approaches sheet metal design from an easy to understand 2D perspective, however final product models are presented in full 3D for review.
- Customers who have never used a CAD system before are productive the first time they sit down to use it.

Bend-Tech Sheet Metal Software\$295.00

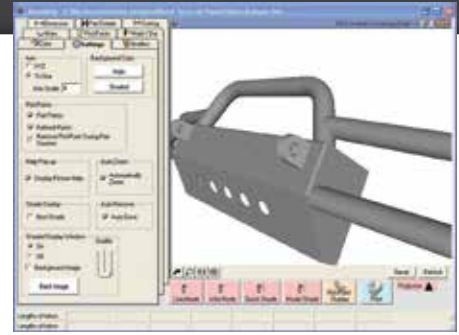

BEND-TECH EXHAUST SOFTWARE



- Bend-Tech Exhaust Design Software gives you the ability to model critical components of a vehicle (axles, mufflers, gas tanks, etc.), to properly design the exhaust tubing around obstructions.
- Create multiple bends and straight lengths in one part and obtain the cutting and bending instructions to build your creation.

Bend-Tech Exhaust Design Software\$295.00

TRICK-TOOLS TUBE BENDER SURVIVAL KIT

- Digital Angle Gauge and Bracket:** Helpful to track rotation of tubing
- AF2:** Use this angle finder to check degree of bend
- TC1:** Tube welding positioner to secure tubes during welding
- Paste Lube:** Use this to save wear on your bender tooling
- Options:** Bend Tech Layout software to assist with part manufacturing

Tube Bender Survival Kit\$169.95
 Tube Bender Survival Kit w/ BT EZ\$219.95
 Tube Bender Survival Kit w/ BT EZ-3D\$299.95
 Tube Bender Survival Kit w/ BT Pro\$425.95



TRICK-TOOLS HAND BENDER

- The HB1 features heavy duty steel construction for bending custom fuel, brake or hydraulic lines or even small diameter chassis tubing up to 5/8 inch OD.
- Quick setup and simple operation make this bender the right choice for light production, repair, and prototype work.
- Each standard die set is reversible for bending three-times or five-times the diameter of the tube radii and the adjustable bend die allows for easy repositioning and removal of the tube.
 - Rugged CNC machined steel construction
 - Replaceable parts for long service life
 - 3D and 5D bends from each die set
 - Adjustable bend die on lead screw
 - Close bend-to-bend distances
 - Simple set up and operation
 - Pedestal or vice mount

HB1KIT (Hand Bender with 3/16" through 5/8" die sets)\$789.98
 Deluxe HB1kit (Includes HB1 bender, 6 die sets, and pedestal w/die rack)\$899.98



Deluxe Hand Bender Kit



Scan for Video

TUBE BENDERS

PRO-TOOLS

MANUAL TUBE BENDERS



- Pro-Tools Model 105HD Tube Bender features 5/8 inch thick main frame arms and easily bends up to 2 inch OD material by hand.
- Graphite impregnated bushings in the ratchet handle and steel bushings at the main die pivot to reduce friction and eliminate wear.
- Dies are sold separately and available for round and square tubing and nominal pipe sizes (NPS).

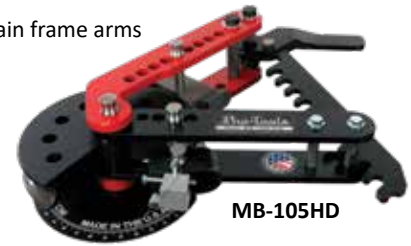

MB-105HD

- **MB-105HD Manual Tubing Bender** (includes steel degree ring and pointer) **SALE!** \$419.99
- **MB-105HD Manual Tubing Bender Deluxe Kit** (includes floor pedestal, degree ring and handle) **SALE!** \$589.95
- **Air/Hydraulic Upgrade Kit for Pro-Tools 105 Benders** **SALE!** \$961.99
- **Electric/Hydraulic Upgrade Kit for Pro-Tools 105 Benders** **SALE!** \$1,493.99

PRO-TOOLS

HYDRAULIC TUBE BENDER



Hydraulic Deluxe Model

- Pro-Tools hydraulic bender kit combines the popular MB-105HD tubing bender with a hydraulic upgrade of your choice along with a rolling stand.
- Features a 2 inch OD x .188 inch wall capacity, popular for building rock-crawlers, buggies, and many other projects
- Steel bushings at the main die pivot to reduce friction and eliminate wear
- The single acting pump eliminates the hard work of manual benders and bends tubing at a much faster rate.
- Dies are sold separately

- **MB-105HD Air/Hydraulic Tubing Bender Deluxe Kit** (includes rolling pedestal, degree ring, and air/hydraulic package) **SALE!** . . . \$1,549.00
- **MB-105HD Elec/Hydraulic Tubing Bender Deluxe Kit** (includes rolling pedestal, degree ring, electric/hydraulic package) **SALE!** . . \$2,081.00

PRO-TOOLS

TUBE BENDER DIES

These dies fit the Pro Tools Model 105HD Tube Benders (shown above) and come in several profiles to bend round tubing, nominal pipe, and square tubing in mild steel, stainless steel, DOM, 4130 chrome moly and more. Many options are available. If you are unsure of what to choose, contact us and we will guide you through the process.

Part No.	Material Size	Center Line Radius	Minimum Wall Thickness	Maximum Degree of Bend	Price
MR1x3x180	1"	3"	.065"	180°	\$299.99
MR1x3.5x180	1"	3.5"	.058"	180°	\$319.99
MR1-1/4x4x90	1-1/4" (1.250)	4"	.065"	110°	\$259.99
MR1-1/4x4x180	1-1/4" (1.250)	4"	.065"	180°	\$359.99
MR1-1/2x5x90	1-1/2" (1.500)	5"	.083"	110°	\$299.99
MR1-1/2x5x180	1-1/2" (1.500)	5"	.083"	180°	\$409.99
MR1-1/2x6x90	1-1/2" (1.500)	6"	.065"	110°	\$319.99
MR1-1/2x6x180	1-1/2" (1.500)	6"	.065"	180°	\$449.99
MR1-5/8x6x90	1-5/8" (1.625)	6"	.083"	110°	\$339.99
MR1-5/8x6x180	1-5/8" (1.625)	6"	.083"	180°	\$469.99
MR1-3/4x6x90	1-3/4" (1.750)	6"	.083"	110°	\$349.99
MR1-3/4x6x180	1-3/4" (1.750)	6"	.083"	180°	\$479.99
MR1-3/4x7x90	1-3/4" (1.750)	7"	.083"	110°	\$409.99
MR1-3/4x7x180	1-3/4" (1.750)	7"	.083"	180°	\$559.99
MR2x7x90	2"	7"	.095"	110°	\$419.99
MR2x7x180	2"	7"	.095"	180°	\$579.99

FOLLOW US ON SOCIAL MEDIA:

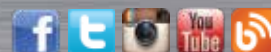

TUBE BENDERS

PRO-TOOLS BRUTE BENDER

Finance as low as \$48.00 / Month



- The Pro-Tools BRUTE Hydraulic Tubing Bender is a seriously heavy duty machine for race car chassis, roll bars, handrails and a lot more.
- With its 2-1/2 inch OD x .188 inch wall thickness tube or 2 inch schedule 80 pipe capacity, the BRUTE can handle almost any job.
- Steel bushings at the main die pivot to reduce friction and eliminate wear
- Features include a 15 ton hydraulic cylinder with a 16 inch stroke, 1 inch thick main bending frame with integrated CNC machined degree ring.
- Dies are sold separately and available for round and square tubing well as nominal pipe sizes.
- Made in the U.S.A.

Pro-Tools BRUTE Hydraulic Tubing Bender (includes bender, 15 ton hydraulic ram, CNC machined degree ring) \$1,949.97
 Pro-Tools BRUTE Hydraulic Tubing Bender Deluxe Kit (includes bender, rolling pedestal, air/hydraulic pump) **SALE!** \$2,649.00
 Pro-Tools BRUTE Hydraulic Tubing Bender Deluxe Kit (includes bender, rolling pedestal, electric/hydraulic pump) **SALE!** \$3,214.00

TUBE BENDERS

BAILEIGH

RDB-125 TUBE BENDER

Finance as low as \$143.00 / Month



- The RDB-125 is an entry level Baileigh/RMD bender with a large bending capacity.
- Capable of bending 180 degrees without repositioning the tooling
- Machine features electric/hydraulic power and a dual-acting cylinder for powered returns.
- Cylinder can be reset and re-stroked using the foot pedal control.
- Quick release counterbend die allows for easy positioning/removal of the material.
- Using industrial grade hydraulics and heavy steel construction, this machine is built to withstand tough industrial jobs.
- Dies are sold separately and available for round and square tubing as well as nominal pipe sizes.
- Made in the U.S.A.

- 2-1/2" round .120" wall mild steel capacity
- 2" round .120" wall chrome moly capacity
- 2" schedule 40 pipe capacity
- 2" square .125" wall mild steel capacity
- 10.5" CLR maximum
- 110v

RDB-125 Bender (110v) **SALE!** \$5,769.00

BAILEIGH

RDB-175 TUBE BENDER

Finance as low as \$216.00 / Month



- The RDB-175 tube and pipe bender features a new programmable bend interface, foot pedal controls, quick tooling changes, and a large 2-1/2 inch OD bending capacity.
- The RDB-175 is very fast; with a unique dual hydraulic ram design, it can make 180 degree bends in as little as 12 seconds.
- With tooling available for round, pipe, and square materials the RDB-175 is one of the most flexible, fast, and repeatable benders on the market today.
- It also features a quick release counter-bend die for easy positioning/removal of the tubing.
- The included auto-stop can easily be set to increase bend accuracy and part consistency.
- Dies are sold separately and available for round and square tubing as well as nominal pipe sizes.
- Made in the U.S.A.

- 2-1/2" round .125" wall mild steel capacity
- 2" round .120" wall chrome moly capacity
- 2" schedule 40 pipe capacity
- 2" square .125" wall mild steel capacity
- 9" CLR maximum
- 110v

RDB-175 Bender (110v) **SALE!** \$8,709.00



BAILEIGH RDB-250 TUBE BENDER

- The RDB-250 tubing bender is a programmable control machine that allows up to 170 programs with 10 bends per program.
- All bend data, including bend angle, speed, and quantities, as well as length and rotational stops can be stored in the memory.
- Optional indexing tables give repeatability for both rotation points and length measurements between bends.
- This rotary draw tube bender can bend at speeds up to 9 seconds for a 180 degree bend and can be programmed to bend up to 360 degrees, great for solid rod applications.
- The counter die positioner has a numerical counter so repositioning of the counter die is a breeze when recalling bend programs.
- Dies are sold separately and available for round and square tubing as well as nominal pipe sizes.
- Made in the U.S.A.

- 2-1/2" OD .125" wall mild steel capacity
- 2" square .125" wall mild steel capacity
- 2" schedule 40 pipe capacity
- On casters for portability

RDB-250 Bender (220v 1ph) SALE! \$13,339.00
Index Table for RDB-250 Tubing Bender (10 ft table) SALE! \$4,587.00
RDB-250 Bender Deluxe Kit (220v 1ph) SALE! \$17,926.00
 (includes RDB-250 Bender, 10ft Indexing Table, and 3-Jaw Chuck)



BAILEIGH RDB-325 TUBE BENDER

- The RDB-325 tubing bender is a programmable control machine that can bend up to 3 inch tubing, 2 inch Schedule 80 Pipe, and 2 inch x .188 inch wall Square tubing.
- This programmable controlled tubing bender allows up to 170 programs with 10 bends per program.
- Optional indexing tables give repeatability for both rotation points and length measurements between bends.
- This rotary draw tube bender can bend at speeds up to 10 seconds for a 180° bend and can be programmed to bend up to 360°, great for solid rod applications.
- The counter die positioner has a numerical counter so repositioning of the counter die is a breeze when recalling bend programs.
- 16.5" CLR maximum
- Dies are sold separately
- On casters for portability

RDB-325 Bender (220v 1ph) SALE! \$18,649.00
Index Table for RDB-325 Tubing Bender (15 ft table) \$5,147.00
Universal Bend Plate for RDB-325 \$1,720.00



Finance as low as \$655.00 / Month

BAILEIGH RDB-350 TUBE BENDER

- The RDB-350 tubing bender is a programmable control machine that can bend up to 3 inch OD tubing, 2-1/2 inch Schedule 40 Pipe, and 3 inch Square tubing.
- The touch screen PLC control allows up to 170 programs with 10 bends per program.
- Optional indexing tables give repeatability for both rotation points and length measurements between bends.
- This rotary draw tube bender can bend at speeds up to 16 seconds for a 180° bend and can be programmed to bend up to 360°, great for solid rod applications.
- The counter die positioner has a numerical counter so repositioning of the counter die is a breeze when recalling bend programs.
- Engaging bends is as simple as pressing the forward and reverse pedal.
- 24" CLR maximum
- Dies are sold separately

RDB-350 Bender (220v 3ph) SALE! \$26,379.00
Index Table for RDB-325 Tubing Bender (20 ft table) \$5,707.00

SWAG OFFROAD MANUAL ROLL BENDER



- The Swag Offroad Hulk Manual Roll Bender is a high-quality made in the USA product with dies available for round and square tubing, round pipe, flat stock, and more!
- Delrin dies are also available for aluminum, copper, brass, and chrome finishes to reduce abrasion or scratches on the material.
- Bender frame is made from 1/4-inch thick plate and the axles are 4340 heat-treated Chromoly
- A digital readout gauge is included for part consistency and repeatability
- Uses 2-ton bottle jack for roll adjustment

- Mild Steel Capacity: 2-1/2" x .120"
- Nominal PIPE Capacity: 2" Schedule 40
- Square Mild Steel Capacity: 2" x .125"
- Minimum OD: 1/4"
- Max Degree of Bend: 360°

6HULKA Swag Offroad Hulk Manual Roll Bender \$899.95
Roll Sets Starting at \$189.95 ea.

TUBE BENDERS

Finance as low as \$112.00 / Month

EAGLE POWERED ROLL BENDERS



CP20

- Roll Benders are used for bending tube, angle, or shapes into coils, circles or large arcs using a wide variety of materials.
- Simply adjusting the third roll changes the size of the arc or circle.
- A digital read out allows repeatability for production runs and machines come complete with a universal roll set allowing you to build the correct size die for your material.
- Tube sizes require specific rolls for each OD and we have rolls for any application including CNC controlled. Please call for special applications.
- These benders are great for handrail applications, race car bumpers, and ornamental iron work.
- Lower rolls knurled for optimal traction
- Manual or hydraulic adjustment of top roll
- Rugged frame and heavy duty wide base
- Hardened steel shafts
- Horizontal or vertical operation options
- Drive components supported in roller bearings
- Heavy duty adjustable lateral material guides
- Compact, low maintenance design
- Hardened universal standard rolls
- Motor overload protection



CP30-PR

Finance as low as \$1.00 / Month

Model	Display	Motor	Speed (rpm)	Weight
CP-20	LED	.44 hp	10	160 lbs.
CP30-MS	LED	1.25 hp	10.5	500 lbs.
CP30-PR	LED	1.5 hp	12	550 lbs.
ZH-402	LED	2.65 hp	15	1,050 lbs.
CP40-H	LED	3.6 hp	14	1,400 lbs.

Model	Tube	Square	Solid	Angle
CP-20	1" x .062"	3/4" x .062"	1/2"	3/4" x 1/8"
CP30-MS	2-3/8" x .062"	1-1/2" x .120"	1-1/4"	1-1/2" x 3/16"
CP30-PR	2-3/8" x .062"	1-1/2" x .120"	1-1/4"	1-1/2" x 3/16"
ZH-402	2-1/2" x .062"	2" x .120"	1-3/8"	2" x 3/16"
CP40-H	2-3/4" x .075"	2" x .120"	1-3/8"	2" x 1/4"

CP-20 (bench top model, manual adjustment w/ LED, 220v 3ph) **SALE!** \$4,520.00
CP30-MS (bench top model, manual adjustment w/ LED, 220v 1ph) **SALE!** \$6,030.00
CP30-PR (includes stand w/ horizontal/vertical operation, manual adjustment w/ LED, foot pedals, 220v 1ph/3ph) **SALE!** ... \$7,830.00
ZH-402 (hydraulic adjustment w/ LED, foot pedal control, 220v 3ph) **SALE!** \$11,990.00
CP40-H (hydraulic adjustment w/ LED, 3 driven rolls, foot pedal control, 220v 3ph) **SALE!** \$18,240.00

HUTH EXHAUST BENDERS

Finance as low as
\$187.00 / Month



HB10



2600HD

- Huth benders provide a fast and versatile option for ram bending tubing, pipe and square and are popular with exhaust shops, as well as industrial applications.
- The HB-10 is Huth's entry level bender, designed to introduce you to Huth quality while showing you incredible profit potential with its standard features.
- Included in the HB-10 package is the model 1600 bender, and tooling for bending and creating joints for exhaust tubing from 1-1/2 to 3 inch OD.
- Not only is this machine capable of bending up to 3 inch OD material, but it can also expand and reduce tubing, and form exhaust ball joints and slip joints.
 - 220v, 1ph or 3ph power options
 - Industrial quality
 - Available tooling packages
 - Expander/Swager included
- The Huth 2600 industrial duty bender is the most powerful bender of its kind and is designed for large diameter or heavy wall applications that cannot be done on conventional machines.
- It offers a knee pedal control, 7.5 hp unit - enough to provide 85,000 lbs of bending force, and a compact control panel.

HB10 Bender with tooling package **SALE!** \$11,120.35
 2600HD Industrial Bender, less tooling **SALE!** \$12,782.25

HUTH FABRICATION BENDER

Finance as low as
\$302.00 / Month

- The Huth 2650 fabrication bender is perfect for the manufacturer looking for a heavy duty machine able to run for multiple shifts.
- Great for structures such as carports, green houses or picnic tables and is versatile enough to bend round tubing, square or rectangle as well as flat bar
- The Smart Automatic Mode features an adjustable return-to-home position control along with a precise and easy to read depth of bend gauge that increases efficiency and ensures fast and easy transitions between multiple bends.



Model	Bending Force	Round Tube Max.	Square Tube Max.	Nominal Pipe Max.
HB2650	58,000 lbs	3" OD x .083"	2-1/2" x .073"	1-1/2" x Sch. 40
HB2660	85,000 lbs	3"OD x .120"	3" x .073"	2-1/2" x Sch. 40

HB2650 Fabrication Bender (less tooling, 220v 1ph or 3ph) **SALE!** \$14,464.23
 HB2660 Fabrication Bender (less tooling, 220v 1ph or 3ph) **SALE!** \$15,194.30

TUBE BENDERS

BAILEIGH MANDREL BENDER



- This square and rectangle mandrel bender is perfect for doing custom chassis and frame rail work.
- The MB-4x2 is capable of bending 100 degrees and can make a 90 degree bend in less than 10 seconds.
- Timed mandrel withdrawal helps increase the quality of bends
- Features a fully programmable computer and USB port for external storage
- A wide variety of tooling is available for square and rectangle (easy and hard way).
 - Repeatability control for consistent parts
 - 3" x 3" x 11 ga square capacity
 - Motor: 5hp, 220v, 3ph
 - Weight: 3500 lbs
 - 2" x 4" x 11 ga rectangle capacity (hard way)

Baileigh MB-4x2 Square & Rectangle Mandrel Bender (mandrel table and tooling sold separately) **SALE!** \$59,839.00



QUALITY TOOLS BACKED BY OUR NO JUNK GUARANTEE

TRANSFLUID MANDREL BENDERS

- The German made K Series mandrel benders are the highest quality design and built with space and portability in mind.
- These machines offer hydraulic muscle with digital accuracy, offering a tolerance of +/- .1 degree.
- With capacity up to 4 inch stainless and bend radii as tight as 1.5 x diameter in their standard configuration, these machines are as versatile as they are economical.
- Optional accessories include mandrel lubrication, length and rotational stops with the plane of bend device, and 500 part storage with the SPS touch screen control. Please call our expert sales staff with all of your bending needs.

DB 2076K

- Bends up to 3" OD x .109" wall thickness mild steel tubing
 - Stainless steel tubing up to 3" OD x .065" wall thickness
 - Bending angle up to 180.0 degrees plus 10.0 degrees of springback
 - Bending head speed 0.0-90.0: 8 seconds
 - Standard load length: 10 feet (extensions available)
 - Minimum centerline radius: 1.5D
 - Maximum centerline radius: 6 inches (extensions available)
 - Manual or semi-automatic operation (with optional SPS control)
 - Includes boosted pressure die and controlled mandrel withdrawal
 - Machine weight: approx. 2,200 lbs
 - Great for automotive exhaust and headers
- Prices start at \$69,300.00**

DB 20101K

- Bends up to 4" OD x 0.134" wall thickness mild steel tubing
 - Stainless steel tubing up to 4" x .078" wall thickness
 - Bending angle up to 180.0 degrees plus 10.0 degrees of springback
 - Bending head speed: 0.0-90.0: 9 seconds
 - Standard load length: 10 feet
 - Minimum centerline radius: 1.5D (optional boosted pressure die for <1.5D)
 - Maximum centerline radius: 7 inches
 - Manual or semi-automatic operation (with optional SPS control)
 - Removable shaft for small bend radius
 - Machine weight: approx. 5,500 lbs.
- Prices start at \$111,500.00**



20101K

DB 2060-3A-CNC



- Bends up to 3" OD x 0.120" wall thickness mild steel tubing
 - Stainless steel tubing up to 2-3/8" x .120" wall thickness
 - Bending angle up to 180.0 degrees plus 10.0 degrees of springback
 - Bending head speed: 35° per second
 - Standard load length: 15 feet
 - Minimum centerline radius: 1.5D
 - Maximum centerline radius: 6 inches
 - Machine weight: approx. 11,500 lbs.
- Prices start at \$179,000.00**

ACCESSORIES



Mandrel Tooling

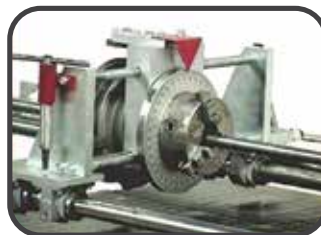

Plane of Bend Device



SPS Control



Mandrel Lubrication

BEAD FORM FOR TUBING

- Bead Form quickly forms pressure hose beads on all types of tubing and is great for fuel and radiator lines.
- Works on steel, aluminum, copper, or brass
- The hand crank can be removed and replaced with a ratchet and 1/4 inch square socket and can be vice or bench mounted with the included bracket.
- Bead Form also comes in its very own carrying case
- Electric upgrade option is available



Bead Form Jr (5/16"-1/2" OD, designed for .028" wall tubing, produces a bead approximately .025" tall)\$559.00
Bead Form I HD (5/8"-2" OD, designed for .050" wall tubing, produces a bead approx. .050" tall x .185" wide)\$499.00
Bead Form II HD (1-1/2"-4" OD, designed for .050" wall tubing, produces a bead approx. .080" tall x .270" wide)\$499.00
Bead Form III HD (1-1/2"-4" OD, designed for .065" wall tubing, produces a bead approx. .080" tall x .270" wide)\$599.00

BEAD FORM ELECTRIC

Finance as low as \$47.00 / Month

- Features a high quality 1/6 hp gear motor with foot pedal control

Model No.	Minimum ID	Steel Cap.	Aluminum Cap.	Stainless Cap.
BF1HDE	9/16"	.050" Wall	.050" Wall	.050" Wall
BF2HDE	5/8"	.065" Wall	.065" Wall	.050" Wall
BF3E	5/8"	.065" Wall	.065" Wall	.065" Wall



Bead Form Electric Upgrade (utilize your existing bead form tool, 110v)\$1,350.00
Electric Bead Form I HD (5/8"-2" OD, 110v)\$1,949.00
Electric Bead Form II HD (1-1/2"-4" OD, 110v)\$1,949.00
Electric Bead Form III HD (1-1/2"-4" OD, for .065" material, 110v)\$1,949.00



Scan for Video

HUTH EXPANDER/SWAGER

Finance as low as \$126.00 / Month



- Tubing expanding capacity is from 1 inch up to 5-1/2 inch ID
- Tube swaging, reducing, and flaring capacity is up to 3 inch OD
- Includes collet holder for 1 inch up to 2-1/2 inch OD tubing, and adjustable collar for expanding 1 inch to 3-1/2 inch tube
- Powerful 5 hp motor, 240v 1ph (30 amp), or 3ph (20 amp)
- Portable design includes heavy duty wheels and front swivel caster with brake
- Great for end forming mild steel, aluminum, stainless steel, black pipe, and tubing
- This tubing expander / steel pipe reducer has 25,000 lbs. of expanding power
- Automatic preset expanding system allows precise expanding every time
- Made in the U.S.A.



Scan for Video

1673 Expander/Reducer/Swager SALE!\$6,386.50

HUTH MITEY MATE JR.



- The Mitey Mate Jr is an air powered offspring of Huth's larger 1673 expanding unit.
- Operates off 80-120 psi of shop air and will produce 17,000 lbs of expanding force.
- Expanding tubing is easy with Huth's Accu-Sizer system, for perfect expansions every time.
- Includes tooling to expand 1-1/2 inch to 3 inch .065 inch tubing.

Mitey Mate Jr Portable Expander SALE!\$1,975.50

BAILEIGH TUBING NOTCHER



TN-250

- The TN-250 tubing notcher is one of the most versatile hole saw notchers on the market today.
- The unique radial vise clamping system allows for clamping tubing from 1 to 2-1/2 inch OD in any location, including the center of a bend.
- Hole saws are supported on a massive 1-1/4 inch OD shaft, which also includes a replaceable hex insert for attaching to a standard 1/2 inch drive drill.
- Sealed needle bearing shaft supports allow for smooth operation
- 1 inch offset notches can be performed by raising or lowering the cutter assembly.
- Bolt or clamp it to a table or simply clamp it in a vise
- 230 degree of angle adjustment

TN-250 Tubing Notcher **SALE!** \$889.00
 TN-250 Tubing Notcher Deluxe Kit (includes floor pedestal, hole saw kit, and notching lube) **SALE!** \$1,069.95



PRO-TOOLS TUBING NOTCHER

- Built around a heavy duty 1/2 inch thick aluminum base plate with a 1 inch diameter shaft supported on sealed ball bearings, this is one heavy-duty notcher!
- This Pro-Tools notcher will handle 3/4 inch through 2 inch diameter tubing at angles up to 60 degrees and uses regular bi-metal hole saws.
- The HSN-501i can be used in a drill press or attached to a table and used with a standard 1/2 inch drive hand drill.
- This tube and pipe notcher also has an adjustable vise for offset notches.



HSN-501i Hole Saw Tube Notcher \$289.99

BAILEIGH TUBING NOTCHER



TN-300 Hole Saw Tube Notcher **SALE!** \$3,509.00

- The Baileigh TN-300 tubing notcher is an industrial-quality hole saw coping machine.
- Vise allows for offset coping up to 1-1/2 inches and features a quick release taper lock system for easy adjustment of the cut angle.
- Capable of notching 3/4 inch through 3 inch tubing with a maximum notch angle of 60 degrees
- With a 110 volt, .5 hp motor, and oil filled gearbox, this rugged combo is built for years of use.

BAILEIGH TUBING NOTCHER



Finance as low as
\$198.00 / Month

- Create perfect weld joints in chrome moly, mild steel, stainless steel, and aluminum pipe or tubing with outside diameters of 1 to 3 inch.
- Does not contaminate the weld joint, offering more strength in the weld.
- With unmatched versatility and mobility, the TN-800 pipe notcher is capable of notching up to 60 degrees in either direction.
- Cross slide table, angle vise, and V-Jaws can be independently calibrated allowing accurate positioning of straight, angled, or offset notches.
- Quick changeover for different diameters of tube
- Ruggedly built stand with large wheels and casters allows for easy mobility.

TN-800 Tubing Notcher (110v, 1ph, 15 amp) **SALE!** \$9,489.00



MITTLER BROS. TUBING NOTCHER

Finance as low as
\$116.00 / Month

- The MB Ultimate Tubing Notcher has been a favorite in fabrication shops for many years.
- Operation is simple; just clamp your tube in the calibrated swivel vise that allows for accurate and repeatable positioning at any angle and a compound feed table advances tubing into the milling cutter, producing a perfect notch and a perfect fit—every time.
- Extreme angles can be achieved because of the swiveling vise and the finished notch requires very little cleanup or deburring.

Standard Ultimate Tubing Notcher (max capacity 3/4" to 2" tubing, 110v)	\$4,695.00
Variable Speed Ultimate Tubing Notcher (max capacity 3/4" to 2" tubing, 110v)	\$5,250.00
Double Sided Variable Speed Ultimate Tubing Notcher (max capacity 3/4" to 2" tubing, 110v) ...	\$6,575.00
Offset Vise Option (allows offset notching of tubes)	\$345.00
Upgrade Vise Option (allows notching of tubes up to 2-3/8" OD)	\$415.00
Ultimate Tubing Notcher Stand (cabinet provides space for safe storage of spare cutters)	\$465.00

(See website for cutter pricing)



V-Block Vise Design Means Minimum Set-up Time

1 HP Standard (1.5 HP Variable Speed Optional)

115v Operation (220v Optional)

Rugged Construction 350 lbs.

Lifetime Sealed Bearings

130 RPM Standard 75-250 RPM Variable Speed

End Mill Design Allows Fast Metal Removal

Calibrated Swivel Vise Allows ANY Angle Setting. Does NOT Clog with Chips!

Notches up to 2-1/2" Diameter Tubing



TUBE NOTCHING & ENDFORMING



Finance as low as
\$39.00 / Month

FEIN GX ABRASIVE SYSTEM

- The Grit GX75 Dual Speed Belt Grinder is the basis for the GX module system.
- Featuring a 3 x 79 inch belt, 3 x 16.5 inch grinding surface, and an 8 inch front contact wheel, this grinder offers plenty of grinding space for almost any application.
- Additional modules include abrasive tube notching and centerless grinding

GRIT MODULES

- The Grit GXR radius grinding module is the perfect solution for tube and pipe notching from 5/8 to 3 inches.
- Convert from grinding to notching within minutes (requires 3" x 88-1/2" belt length)
- Standard features include a quick clamping system, traverse carriage, indexed degree table, and depth stop.



- The Grit GXC Centerless Grinding System by Fein can create the perfect surface finish on round tubing, with a very simple operation.
- The GXC features high process speeds along with an infinitely adjustable feed rate of the material.
- A variety of abrasives are available in order to achieve the right finish whether you are removing mill scale or creating a satin finish on stainless handrail.
- Two types of rail guides are included, brass for rough surfaces, and nylon for more delicate finishes.

GX75 Belt Grinder (220v 3ph or 440v 3ph, add \$390.00 for 2 speed) SALE!	\$1,988.00
GXR Pipe Notching Module SALE!	\$1,559.00
GXC Centerless Grinding Module SALE!	\$1,759.00
3 x 79" Belts (10 Pack) SALE!	Starting at: \$102.06

FOLLOW US ON SOCIAL MEDIA:





FEIN GI ABRASIVE SYSTEM

- The Grit GI150 is the ultimate workhorse for your industrial grinding needs.
- Featuring a 6 x 79 inch belt, 6 x 18 inch grinding surface, and an 8 inch front contact wheel, this grinder offers plenty of grinding space for almost any application.
- Additional modules include abrasive tube notching and centerless grinding

- Belt Speed: Single Speed = 7400 SFPM
- Belt Speed: Two Speed = 3700 / 7400 SFPM
- 5hp motor
- RPM: 1730 / 3450

GRIT MODULES

- The Grit GIR radius grinding module is the perfect solution for tube and pipe notching from 3/4 to 6 inches.
- Convert from grinding to notching within minutes (requires 6 x 89" belt length)
- Standard features include a quick clamping system, traverse carriage, indexed degree table, and depth stop.



- The Grit GIC Centerless Grinding System by Fein can create the perfect surface finish on round tubing, with a very simple operation.
- The GIC features high process speeds along with an infinitely adjustable feed rate of the material from 0 to 6.5 ft/min.
- A variety of abrasives are available in order to achieve the right finish whether you are removing mill scale or creating a satin finish on stainless handrail.
- Two types of rail guides are included, brass for rough surfaces, and nylon for more delicate finishes.

GI150 Belt Grinder (220v 3ph or 440v 3ph, add \$720.00 for 2 speed) SALE!	\$3,338.00
GIR Pipe Notching Module SALE!	\$2,999.00
GIC Centerless Grinding Module SALE!	\$3,429.00
6 x 79" Belts (10 Pack) SALE!	Starting at: \$181.90

SCOTCHMAN ABRASIVE NOTCHER



- Scotchman Abrasive Tube Notchers are fast and cost effective methods to fit tubes together.
- The high speed grinding belt provides a smooth polished surface at any angle from 0 to 60 degrees in tubing from 3/4 inch up to 3 inch OD.
- The guarded belt surface on top is ideal for grinding or deburring.
- With a 110 volt, .5 hp motor, and oil filled gearbox, this rugged combo is built for years of use.
- Also features a heavy duty frame and base construction, tool free belt and mandrel change over, mandrel center-line adjustment, along with two pipe mandrels and two belts.
- 3 year manufacturer's warranty

AL100U-01 Abrasive Notcher (220v 3ph or 440v 3ph, 4hp, add \$700.00 for 220v 1ph)	\$5,595.00
AL100U-02 Abrasive Notcher w/ Cross Feed Vise (220v 3ph or 440v 3ph, 4hp, add \$700.00 for 220v 1ph)	\$6,595.00

FEIN DEBURRING MACHINE

Finance as low as \$27.00 / Month

- Grit deburring machine is a great addition to any production line.
- Highly effective for deburring pipe, tube, profiles, and flat materials.
- A variety of deburring brushes are available
- Dust collector connection is available
- Standard machine can be bench mounted to an optional pedestal.



GXE Deburring Machine SALE	\$1,089.00
Deburring Machine Stand	\$471.00
Wire Brush for Grit Deburring Machine	Starting at \$279.60

MITTLER BROS.

HYDRAULIC NOTCHERS



100-U-MB

- The Mittler Brothers Hydraulic Tube Notchers are precision-machined units based on a punch and die design.
- These notchers utilize a 10 ton ram, capable of notching up to 2-3/8 inch OD tubing and 2 inch Schedule 40 pipe.
- These notchers have a maximum notch angle of 90 degrees and can even handle limited angles when necessary.
- Can be used in a bench vice, fixed stand, or stand with wheels
- Produces a perfect, ready-to-weld notch every time and turns out a professional piece again and again.



100-MB

100-MB (2 inch OD capacity, Choice of one die)	\$1,170.00
100-U-MB (2-3/8 inch OD capacity, Choice of one die)	\$1,415.00
Air/Hydraulic Pump, 6ft Hose and Fitting	\$423.00

IRONWORKER

NOTCH TOOLING



- Built to fit in a press or ironworker
- Cutting edges made from A2 and D2 air hardened tool steels
- Requires #1000 series standard housing
- Angle notch units available, call with application
- Larger sizes available as well as punching, slotting or shearing

1000-PTD Notcher Housing (accepts up to 2-1/2" OD)	\$286.75
1000-1-PTD Notcher Housing (accepts 2-5/8" - 3-1/2" OD)	\$1,146.99
1000 Series Punches and Dies (one set required for each OD)	Starting at: \$550.09 ea.

PIPEMASTER

CONTOUR GAUGES

- PipeMasters are the perfect companion to any of our notchers and will easily pay for themselves when fitting tube or pipe together.
- The steel pins contour to the shape desired which can be transferred to the work piece.
- Individual sizes will slip over the tube with a .020 inch clearance or can be used free hand.
- These time savers take away the stress of making complicated notches for your tubular project.



Scan for Video

P/N	Tube Size	Price
PT075	3/4"	\$46.20
PT0875	7/8"	\$47.30
PT100	1"	\$46.20
PT1125	1-1/8"	\$49.50
PT125	1-1/4"	\$48.40
PT1375	1-3/8"	\$56.10
PT150	1-1/2"	\$53.90
PT1625	1-5/8"	\$53.90
PT175	1-3/4"	\$59.40
PT200	2"	\$61.60
PT250	2-1/2"	\$151.80

P/N	Nominal Pipe Size	Pipe OD	Price
P100	1"	1.315"	\$47.30
P125	1-1/4"	1.660"	\$53.90
P150	1-1/2"	1.900"	\$61.60
P200	2"	2.375"	\$62.70
P250	2-1/2"	2.875"	\$121.00
P300	3"	3.500"	\$126.50
P400	4"	4.500"	\$189.20
P500	5"	5.563"	\$209.00
P600	6"	6.625"	\$343.20

P-SC PipeMaster Stock Car Kit (1-1/2", 1-3/4")	\$113.30
P-TJ PipeMaster Truck & Jeep Kit (1-3/4", 2")	\$121.00
P-DR PipeMaster Dragster Kit (1-1/2", 1-5/8")	\$107.80
P-PRKit PipeMaster Pro Racer Kit (1", 1-1/4", 1-1/2", 1-3/4", 2")	\$269.50
PT-2Kit PipeMaster Master Builder Kit (11 sizes, 1/8" increments, 3/4"-2" OD)	\$608.30
P-1Kit Nominal Pipe Size Kit (1", 1-1/4", 1-1/2", 2" pipe)	\$225.50

Call for sizes not shown

TUBE NOTCHING & ENDFORMING

BEND-TECH TUBE CUTTING SYSTEM



SOFTWARE

Bend-Tech INDUSTRIAL: Has the ability to work with your 3D solid model CAD designs. Also includes several tubing designers including our easy-to-use assembly designer.

Bend-Tech Dragon Software: An automated CAM product that understands tubing and will automatically create your cutting, marking and etching paths directly from Bend-Tech Industrial. Bend-Tech Dragon software comes with a nesting ability to allow several parts on the same stock tube.



Plasma cutting: Cuts end profiles, holes, and other contours.



Tool changer: Machine will switch between marker/etcher/plasma/laser pointer automatically depending on your intended tasks.



Tube marking/etching: Bend-Tech Dragon obtains the bending information from the Bend-Tech Industrial software to automatically mark and etch bend angle labels, bend locations and rotations.

A400 MACHINE SPECS

Machine Length:

12 ft and 24 ft options available

Tube Size:

Round: 0.50" - 6" Diameter (up to 2" using pass through chuck)

Square: 0.50" - 4.0"

Rectangle: 0.50" to 4.0" width x 0.50" to 4.0" height

Tube Weight: 400 lbs maximum

Speed of Cutting:

Varies by material. Up to 250 inches per minute.

A250 MACHINE SPECS

Machine Length:

12 ft and 21 ft options available

Tube Size:

Round: 0.75" - 4" Diameter (up to 2" using pass through chuck)

Tube Weight: 260 lbs maximum

Speed of Cutting:

Varies by material. Up to 250 inches per minute.

- Bend-Tech Dragon is a complete solution for tube cutting, etching, and marking combined with the world's most powerful software for tube design and manufacturing.
- Dragon has capabilities of plasma cutting end profiles, holes, and contours in round tubing.
- Bend-Tech Dragon will also mark or etch your bending information; including bend angle labeling, bend location line-up marking, and weldment fit-up locations.
- A pass through chuck feeds the tubing and allows for pieces that are longer than the machine to be manufactured.
- The support yoke is designed to guide the tubing even if the material stock is not perfectly straight.
- The easy to understand control panel is built with LED lights to tell the operator exactly what the machine is doing and is designed for the most novice of machine operators.
- Windows PC is required and is sold separately. This system will not operate on Apple (IOS) platform.
- An optional Technology Package Accessory is available and includes computer, preloaded software, computer cabinet, and more!
- An optional Water System is available to increase cut quality, reduce slag, keep material cooler, and extend torch consumable life.

Bend Tech Dragon A250 Tube Cutting System, 12 ft (plasma sold separately) Call for Pricing
Bend Tech Dragon A400 Tube Cutting System, 24 ft (plasma sold separately) Call for Pricing

ARCLIGHT DYNAMICS CNC PLASMA TABLES

ArcLight Dynamics CNC plasma table represents the very best in small shop CNC plasma tables at an affordable price. The control system is one of the most feature rich on the market, and comes with a two year warranty, plus support. Their heavy duty frame increases the strength of the table, reduces noise and vibration, and increases table accuracy and cut quality. All ArcLight Dynamics plasma tables ship fully assembled and tested less plasma torch. If a plasma torch is purchased along with your table, it can be complete and ready to run. All Arclight packages include a fully assembled ArcLight Dynamics plasma system with computer and software.



SOFTWARE

- Mach 3 control software
- Solid Edge 2D CAD software
- Sheetcam CAM software
- GIMP and Inkscape drawing Software

STANDARD FEATURES

- Automatic torch height control
- Precision rack and pinion dual drive gantry
- Water table
- Cable management on both axis
- Industrial strength frame
- Magnetic release torch holder
- Filtered control cabinet
- 2 year warranty on all electronics
- Computer with flat screen monitor

2 X 2 CNC PLASMA TABLE

- The Arc Pro 2400 table is the smallest table ArcLight offers, however it still features the same standard components as the larger plasma tables.
- 26 x 26 inch Cutting Envelope
- Perfect for schools, home shops, and for those with limited space.



2' x 2'



5' x 5'

5 X 10 CNC PLASMA TABLE

- The Arc Pro X 12000 table can handle up to 1" thick plate and is designed to take your fab shop to the next level.
- 123 x 64 inch Cutting Envelope
- Built for fabrication shops and manufacturing companies cutting large parts and production runs

5 X 5 CNC PLASMA TABLE

- The Arc Pro X 6000 table is excellent for the shop needing the width of a 5 x 10 ft table but doesn't have space for its larger footprint.
- 66 x 53 inch Cutting Envelope
- Excellent for smaller shops that are cutting large parts or small production runs



5' x 10'

Finance as low as \$595.00 / Month

ArcLight Dynamics 2 x 2 CNC Plasma Table	\$9,250.00
ArcLight Dynamics 5 x 5 CNC Plasma Table	\$13,450.00
ArcLight Dynamics 4 x 8 CNC Plasma Table	\$15,450.00
ArcLight Dynamics 5 x 10 CNC Plasma Table	\$23,950.00
Auto Tracer (draw artistic shapes by hand and easily copy them into your CAD)	\$395.00
Pipe Tube Cutter (cuts 1" to 10" OD tubing, cope the ends of tube and cut decorative images into round pipe)	\$1,100.00
CNC Plate Marker (engrave serial numbers, company logos, artwork, or indicator lines in parts)	\$1,750.00



ARC-ZONE MONSTER NOZZLE KITS

This kit from Arc-Zone includes everything needed to convert your WP-17, 18, 26, CS300, CS410, and CK 3 model TIG torch to the Monster™ Gas Nozzle. These nozzles are engineered to deliver a steady umbrella of shielding gas to improve your TIG weld quality, reduce post-weld clean up, and minimize weld distortion.



- (1) No. 12 = 3/4" (19.0mm) Orifice Size with Engineered Screen Pack Installed
- (1) No. 14 = 7/8" (22.2mm) Orifice Size with Engineered Screen Pack Installed
- (1) No. 16 = 1" (25.4mm) Orifice Size with Engineered Screen Pack Installed
- (1) No. 24 = 1-1/2" (28.5mm) Orifice Size with Engineered Screen Pack Installed
- (3) ArcTime™ Hyperperformance All-Purpose Rare Earth Tungsten Electrodes
- (1) High Performance Wedge Collet
- (2) Gass Lens Collet Bodies
- (1) Teflon Nozzle Gasket
- (1) Short "Button" Back Cap
- (1) Medium Back Cap
- (1) Long Back Cap
- (1) Spare Back Cap O-Ring
- (1) Gas Flow Tester
- (1) E-Z Wipe Weld Prep Packet
- (1) Handy TIG Welding Calculator



- Monster Nozzle Pro Kit for 9/20 & 2-Series TIG Torches** (compatible with WP-9, 20, 20F, Crafter Series CS310, CK-2 torches) **\$158.88**
- Monster Nozzle Pro Kit for 17/18/26 & 3-Series Torches** (compatible with WP-17, 18, 26, CS300, CS410 and CK-3 Series Torches) . . **\$178.88**
- Individual Nozzle Kits for TIG Torches** (No. 12, 14, 16, for 9/20 & 2-Series and 17/18/26 & 3-Series available) **Starting at \$65.25**
- ArcTime Hybrid Tungsten Electrodes, 10 pack** (1/16" and 3/32" packs available) **Starting at \$17.79**

ARC-ZONE LOW PROFILE NOZZLE KITS



Get in those hard to reach places with the LowRider Stubby and 'Slammed' Nozzle kits. Compatible with a variety of popular tig torches, the LowRider Stubby and 'Slammed' kits decrease the torch head up to 5/8" depending on the torch series. The LowRider nozzles also ensures the gas coverage needed to get the perfect weld and are light weight to minimize torch shake. See which kit fits your tig torch below.

- (1) LowRider orifice
- (1) LowRider gas lens collet body
- (1) LowRider collet
- (1) Collet body wrench
- (1) LowRider Insulator
- (1) Short "button" back cap (if applicable)
- (2) Precision ground electrode

- A-LR-2-332 LowRider Nozzle Kit for 9, 20, & 2 Series Torches** (1/4" shorter than standard #8 nozzle) **\$70.00**
- A-LR-8-332 LowRider Nozzle Kit for 24 & 8 Series Torches** (3/8" shorter than standard #8 nozzle) **\$55.00**
- A-LRS-2-332 LowRider Slammed Nozzle Kit for 9, 20, & 2 Series Torches** (1/2" shorter than standard #8 nozzle) **\$85.00**
- A-LRS-8-332 LowRider Slammed Nozzle Kit for 24 & 8 Series Torches** (over 5/8" shorter than standard #8 nozzle) **\$48.00**

ARC-ZONE SHARPIE TUNGSTEN GRINDER

- Cut, sharpen, and grind your tungsten electrodes anywhere with the Sharpie DXCL Cordless Tungsten Grinder Pro Kit from Arc-Zone.
- This Pro Kit includes collets for 0.040 inch (1mm), 1/16 inch (1.6mm), 3/32 inch (2.4mm), and 1/8 inch (3.2mm) tungsten.
- This unit is variable speed and ranges from 5,000-32,000 RPM.
- Adjust the grinding angle from 15 to 45 degrees for the perfect grind
- The Milwaukee M12 Lithium battery can fully charge in 30 minutes.



- Sharpie DXCL Cordless Tungsten Grinder Pro Kit SALE** **\$417.00**
- SharpieDX Tungsten Grinder Attachment** (recommended to be used with Milwaukee M12 rotary tool) **\$275.00**

STRONGHAND

MAGNETIC POSITIONERS

MAV120



- Positioning magnets are the perfect accessory for any fabricator.
- These tools feature an on/off switch to make repositioning a breeze.

MAV120 Adjust-O Angle Magnet	\$286.00
MS2-80 6" Dual Switch Magnet (78 lbs. of force)	\$134.00
MS2-90 8" Dual Switch Magnet (150 lbs. of force)	\$230.00

MS2-80



TRICK-TOOLS

WELDER'S SURVIVAL KIT

This kit features an assortment of our best selling and most useful welding clamps and magnets! Included in this 9 piece kit, you'll find a variety of tools to help you out, no matter what you're welding.

- | | |
|-----------------------------|-------------------------------------|
| (1) Shark Clamp | (1) Multi-Purpose Pliers |
| (1) Corner Magnet Twin Pack | (1) Standard Positioning Magnets |
| (2) Tab and Bracket Holders | (1) Multi-Purpose Pliers w/ V- Pads |
| (1) Adjust-O Magnet Square | (1) Clip on V-Pad |



WSK Welder's Survival Kit **SALE!** \$196.65

TRICK-TOOLS

TUBE WELDING POSITIONERS

TC1



- This tube welding positioner is a great tool for race car builders and tube fabricators
- Can be adjusted to any angle and securely hold parts for tack welding without magnetizing
- This simple tool can save hours of frustration when working with coped tubes.

TC1 Tube Welding Positioner (1"-2" OD)	\$38.95
TC1 Tube Welding Positioner Buy two and save!!	\$69.90
TC2 Tube Welding Positioner (1-3/4"-3" OD)	\$45.95
TC90 90° Fixed Tube Welding Positioner (1"-2" OD)	\$26.00
TCKit Tube Welding Positioner Kit (Set of 4 includes 2-TC1s, 1-TC90, and 1-TBH)	\$119.95

STRONGHAND

GROUND MAGNET

- PowerBase Ground Magnet is the perfect solution to slipping or hard to use ground clamps
- Rated up to 500 amps with a holding force of up to 110 lbs
- V-groove base works with flat and round surfaces

Welding Ground Magnet \$108.00



STRONGHAND

TORCH HOLDER



- MIG and TIG gun holders provide a great place to hang your welding torch, as well as a place to put nozzle gel.
- Magnetic base allows you to place the holder anywhere on the table.

MRT15 TIG Torch Holder	\$20.95
MRM12 MIG Torch Holder	\$29.50
MRM13 MIG Torch Holder (with Pliers)	\$40.50



HEL-HOOK

WELDING BOTTLE ORGANIZER



- Stop hanging your welding helmet and leads on the regulator!
- This four hook assembly slips over the top of your welding bottle and provides a sturdy place to store PPE gear, welding helmet, leads, bottle cap, wrenches and more!
- Hanger is laser cut from 3/16 steel and is tumbled after cutting for smooth uniform edges
- Comes in kit form and easily fits together with slotted construction
- Weld together in just minutes and it's ready to go!
- Made in the USA

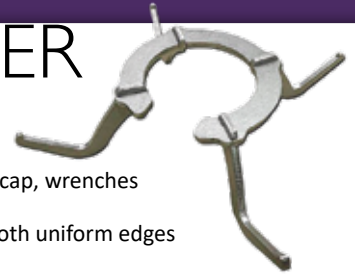

MCY-00012 Hel-Hook Welding Bottle Organizer\$29.95

ARC-ZONE

WELDING POSITIONER

- The Arc-Zone Pro welding positioner features a small footprint with heavy duty performance.
- This positioner features a 110 lb horizontal and 66 lb vertical weight capacity.
- Tabletop is adjustable from 0 to 90 degrees
- This unit also has a 200 amp rating, using a solid copper center spindle grounding block and a convenient whip lead connection.
- Reversible variable speed control unit, on/off foot pedal, speed dial, and center purging capabilities come standard.
- Optional 2.5" and 4" chucks available
- 110v, 50/60 Hz



A-PT-051-PRO Tabletop Welding Positioner (w/ 7.8" diameter plate)\$1,299.00
 A-PT-C025 2.5" Speed Chuck for A-PT-051 Welding Positioner\$320.00
 A-PT-C040 4" Chuck for A-PT-051 Welding Positioner\$384.00

ROTO-STAR

WELDING POSITIONERS

- Roto Star welding positioners are a must for precision welding.
- Can be ordered with a standard 3 jaw chuck with thru-hole and 250 lbs of capacity, or a surface plate for fixturing work pieces.
- Adjustable from 0 to 90 degrees in 15 degree increments
- Features a 300 amp double grounding system which eliminates feedback during high frequency welding
- Reversible variable speed control unit and foot pedal for hands free operation

Roto1 (w/ 6" chuck) (add \$520 for variable spd pedal) **SALE!**\$2,799.00
 Roto1-P (w/ 12" surface plate) (add \$520 for variable spd pedal) **SALE!**\$2,289.00
 Roto3 (w/ 8" chuck) (add \$520 for variable spd pedal) **SALE!**\$3,559.00
 Roto3-P (w/ 16" surface plate) (add \$520 for variable spd pedal) **SALE!**\$3,049.00

Finance as low as \$56.00 / Month

Roto1-P



Roto1-C



Specifications	Roto Star 1	Roto Star 3
Chuck	6" 3 Jaw	8" 3 Jaw
Max. Swing @ 0	16"	20"
Vertical Weight Cap	200 lbs.	250 lbs.
Horizontal Weight Cap	100 lbs.	150 lbs.
Thru Spindle Cap	1-1/2"	2-1/2"
Spindle Rotation	360°	360°
Spindle Speed	0-15 rpm	0-13 rpm
Voltage	110 or 200v	110 or 200v
Optional Table	12" dia	16" dia

IC ENGINEWORKS

HEADER MODELING BLOCKS



- Makes modeling custom headers and turbo manifolds easier
- Piece blocks together and rotate to create a model of your custom header
- Blocks snap together to form header primaries that can be duplicated by cutting and welding commonly available prebent U-bends and J-bends.
- Straight and curved blocks in a variety of radii are included with each kit.
- Each block represents a 1 inch arc length of tubing.
- Just attach the adapter tool to your exhaust flange and start building
- Pro kits have enough blocks to complete a set of headers for an 8-cylinder engine.



1-5/8" Basic Kit (124 pcs)	\$449.99
1-5/8" Pro Kit (248 pcs)	\$799.99
1-3/4" Basic Kit (154 pcs)	\$449.99
1-3/4" Pro Kit (300 pcs)	\$799.99
1-7/8" Basic Kit (184 pcs)	\$449.99
1-7/8" Pro Kit (368 pcs)	\$849.99
2" Basic Kit (124 pcs)	\$449.99
2" Pro Kit (248 pcs)	\$799.99

IC ENGINEWORKS

TURBO MANIFOLD MODELING BLOCKS



- Makes modeling and fabricating custom turbo manifolds quicker and easier
- Blocks come in straight and a variety of center line radii and degree to replicate common stainless cast pipe elbows.
- Blocks simply snap together with the ability to rotate to create the exact radius necessary for your compact turbo manifold design.
- Each block features index points to aid in block rotation.
- The included block adapters enable you to build your custom manifold design on the vehicle and aid in avoiding obstacles for the perfect design.
- Once a design is made, metal parts can be cut and welded to replicate your model.

1-1/4" NPS Basic Kit (1.66" OD, 184 pcs)	\$499.99
1-1/4" NPS Pro Kit (1.66" OD, 368 pcs)	\$899.99
1-1/2" NPS Basic Kit (1.90" OD, 214 pcs)	\$549.99
1-1/2" NPS Pro Kit (1.90" OD, 428 pcs)	\$999.99

IC ENGINEWORKS

FE MODELING BLOCKS



- Makes quick work of designing full exhaust systems, cat back systems, intercooler or turbo downpipe assemblies, and cold air intakes.
- FE Series kits work similarly to the header blocks by simply snapping together with the ability to rotate and create the exact radius necessary for your design.
- Blocks come in straight and curved blocks in a variety of center line radii and 15 degree sections.
- Each block features index points to aid in block rotation and obtaining the perfect radius.
- Once a design is made, metal parts can be cut and welded to replicate your model.

2-1/2" Full Exhaust Basic Kit (134 pcs)	\$649.99
2-1/2" Full Exhaust Pro Kit (208 pcs)	\$899.99
3" Full Exhaust Basic Kit (134 pcs)	\$649.99
3" Full Exhaust Pro Kit (208 pcs)	\$899.99

ICENGINEWORKS TUBE CUTTING JIGS



- Use this cutting system from Icingenetworks with a vertical band saw to simplify the process of cutting prebent U-bends and J-bends.
- Cutting board is designed to be aligned with the fence of a vertical bandsaw and slid across the table of the bandsaw
- Guide blocks match inside radius of tubing
- Aids in cutting tubing perfectly perpendicular to the tangent



1-5/8" Header Tube Cutting System	\$649.99	1-1/4" NPS Pipe Cutting System	\$449.99
1-3/4" Header Tube Cutting System	\$699.99	1-1/2" NPS Pipe Cutting System	\$474.99
1-7/8" Header Tube Cutting System	\$749.99	2-1/2" Exhaust Tube Cutting System	\$974.99
2" Header Tube Cutting System	\$649.99	3" Exhaust Tube Cutting System	\$974.99

ICENGINEWORKS TACK WELD CLAMPS



- Clamps allow the fabricator to preview and adjust pieces before they are tack welded together.

1-5/8" Exhaust Tack Welding Clamp Set (4 pcs)	\$109.99
1-3/4" Exhaust Tack Welding Clamp Set (4 pcs)	\$109.99
1-7/8" Exhaust Tack Welding Clamp Set (4 pcs)	\$109.99
2" Exhaust Tack Welding Clamp Set (4 pcs)	\$109.99
2-1/2" Exhaust Tack Welding Clamp Set (4 pcs)	\$149.99
3" Exhaust Tack Welding Clamp Set (4 pcs)	\$149.99



ICENGINEWORKS FULL HEADER SYSTEM

Finance as low as \$38.00 / Month

- This complete exhaust header fabrication system from Icingenetworks will take you from concept to completion of custom headers and turbo manifolds. The system includes modeling blocks, tube cutting jigs, and welding clamps.

1-5/8" Pro Full System (includes Pro Modeling Kit, Cut Tool System, Tack Weld Clamp Set)	\$1,549.99
1-3/4" Pro Full System (includes Pro Modeling Kit, Cut Tool System, Tack Weld Clamp Set)	\$1,599.99
1-7/8" Pro Full System (includes Pro Modeling Kit, Cut Tool System, Tack Weld Clamp Set)	\$1,699.99
2" Pro Full System (includes Pro Modeling Kit, Cut Tool System, Tack Weld Clamp Set)	\$1,549.99
2-1/2" Full Exhaust Fabrication System (includes Pro Modeling Kit, Cut Tool System, Tack Weld Clamp Set)	\$1,999.99
3" Full Exhaust Fabrication System (includes Pro Modeling Kit, Cut Tool System, Tack Weld Clamp Set)	\$1,999.99

WELDING & PLASMA CUTTING

STRONG HAND RHINO CART

Finance as low as \$64.00 / Month



- The 48 x 30 inch Rhino Mobile Fixturing Station is unlike any welding cart on the market!
- Features a nitrated BuildPro welding tabletop and accepts all BuildPro accessories.
- Tabletop also features a black oxide finish and is reversible if one side is damaged.
- Comes complete with a 66 piece fixturing kit, heavy duty casters, and leveling feet.
- Rhino Cart provides plenty of storage for welding fixtures, clamps, and welding supplies.
 - Table Height: 36 inches tall
 - Hole Spacing: 2.000 +/- .0015
 - Hole Diameter: .625 +/- .002 inch
 - Plate Thickness: .625 inch

StrongHand Rhino Cart Mobile Fixturing Station SALE!	\$2,750.00
Stainless Steel cover for StrongHand Rhino Cart	\$239.95
Deluxe StrongHand Rhino Cart Mobile Fixturing Station SALE!	\$3,139.95

(Deluxe Kit includes Stainless Steel Table Cover, Fold-down Plasma Cutting Tray, and Grinder / Vise Receiver Mount)

Included Fixturing Kit Components:

(10) T55055 Adjustable Lock Bolts	(2) UDN5150 Inserta Clamps	(4) T54203 1.5 inch Locate Stops	(12) T50737 Magnetic Rest Spacers
(2) T54201 Locating Pins	(2) T54217 Inserta Clamp V-Pads	(8) T54216 V-Blocks	(2) T50304 2 inch Angle Brackets
(2) PTT522K 2.3 inch Inserta Pliers	(2) TCX5210 Side Clamps	(4) T54211 V-Block Spacers	(4) T50305 4 inch Angle Brackets
(2) PTT634K 4 inch Inserta Pliers	(4) T54205 2 inch Locate Stops	(8) T50632-01 D-Stop Bars	

BUILDPRO FIXTURING TABLES

- The most adaptable welding and fixturing system on the market.
- Features a modular design that allows the precision ground and CNC machined top plates to be reconfigured to extend the width of the table for larger projects.
- Table is easy to set-up and tear down, saving valuable workspace.
 - Heavy duty leveling feet
 - 1-3/4" spacing between plates
 - Table flatness: .004 inch/ft
 - Hole diameters: .625 inches
 - Hole spacing: 2.00 inches
 - Plate thickness: .625 inches



47" x 38" Standard Table (add \$500 for Nitrided Table)	\$2,310.00
47" x 46" Standard Table (add \$550 for Nitrided Table)	\$2,860.00
78" x 38" Standard Table (add \$750 for Nitrided Table)	\$3,470.00
78" x 46" Standard Table (add \$800 for Nitrided Table)	\$3,990.00
94" x 46" Standard Table (add \$900 for Nitrided Table)	\$4,780.00

BUILDPRO MAX TABLES

- MAX tables feature a continuous plate tabletop surface with 33% more machined holes than the standard slotted tables, for a maximized work surface.
- Just like the standard BuildPro tables, the MAX series features a modular design, allowing the plates to adapt to your project no matter the size.
 - Heavy duty leveling feet
 - Continuous plate design
 - Table flatness: .004 inch/ft
 - Hole diameter: .625 inches
 - Hole spacing: 2.00 inches
 - Plate thickness: .625 inches



94" x 48" BuildPro MAX Standard Table (add \$940.00 for Nitrided Table) **\$5,150.00**

STIEGMUND SYSTEM 28

Finance as low as
\$171.00 / Month

- These German constructed tables feature five fixturing surfaces constructed from 1 inch (25mm) thick plate with additional reinforcement underneath the work surface.
- Fixture mounting holes are CNC machined to 28mm diameter, spaced 100mm apart, and have a flatness rating of +/- .0025 inches per foot.
- These tables are constructed from a hardened steel before going through a plasma nitride treatment to achieve a hardness rating of over 750 Vickers (HV) (60.5 Rockwell).
- See our website for accessory and leg options



System 28 Table

47" x 47" System 28 Welding Table (Stationary Legs included)	\$4,517.00
78" x 39" System 28 Welding Table (Stationary Legs included)	\$5,725.00
94" x 47" System 28 Welding Table (Stationary Legs included)	\$7,258.00
78" x 78" System 28 Welding Table (Stationary Legs included)	\$9,821.00
118" x 59" System 28 Welding Table (Stationary Legs included)	\$10,343.00
157" x 78" System 28 Welding Table (Stationary Legs included)	\$15,880.00



SYSTEM 16

- These German constructed tables feature five fixturing surfaces constructed from 1/2 inch (12mm) thick plate with additional reinforcement underneath the work surface.
- Fixture mounting holes are CNC machined to 16mm diameter, spaced 50mm apart, has a flatness rating of +/- .0025 inches per foot, and a hardness rating of over 750 Vickers (HV).
- See our website for accessory and leg options

39" x 19" System 16 Welding Table (Stationary Legs included)	\$1,723.00
47" x 31" System 16 Welding Table (Stationary Legs included)	\$2,422.00
47" x 47" System 16 Welding Table (Stationary Legs included)	\$2,949.00
78" x 39" System 16 Welding Table (Stationary Legs included)	\$4,074.00
95" x 47" System 16 Welding Table (Stationary Legs included)	\$5,733.00
118" x 59" System 16 Welding Table (Stationary Legs included)	\$8,188.00



System 16 Table

(See our website for imperial tables with engraved inch scales and hole spacing on 4-inch centers.)

WELDING & PLASMA CUTTING

BADASS WORKBENCH

Finance as low as
\$144.00 / Month

There is likely no piece of equipment in a shop that sees more use than the workbench, so why not have a Badass Workbench that is guaranteed not to let you down? Badass Workbenches are made in the USA and carry a lifetime warranty! They are built to last and feature extreme-duty construction unlike anything available on the market today. Whether welding, grinding, cutting, or hammering, we know that your work is demanding and you deserve a workbench that can hold up to the kind of abuse that you can dish out.

- Badass Workbenches are available in 3-bay, 2-bay, and single drawer models and stand 37.5 inches tall x 32 inches deep.
- Standard top is 3/8 inch thick and comes with a 3-inch tall backsplash
- The heavy-duty frame is built from 4-inch square tubing and has a maximum capacity of 4800 lbs.
- Table comes standard with leveling feet, however optional heavy-duty rolling casters, rated at 1200 lbs each, are available.



3BAY



2BAY

- Built into the heavy-duty 4-inch square frame are 8 swivel opening drawers with magnetic closures with a 450 lb capacity each!
- The patented drawer hinge design features a 1-inch solid steel hinge rod, with grease fittings for each drawer, meant for a lifetime of service.
- Optional drawer divider kits are available for increased drawer organization

Available Drawer Options:

- 3-inch deep x 24-inch wide
- 6-inch deep x 24-inch wide
- 9-inch deep x 24-inch wide
- Power drawer/cabinet



- Receiver mounts are fitted at the end of the workbench and accept the Versa-Mount line of tool mounts to keep your tabletop surface free of clutter.
- Mount a grinder, bench vise, Beverly Shear, Roper Whitney punch, or any number of tools when you need them, and remove them when you don't.
- Looking for a customized workbench? See below for a few customizable options and call one of our Solution Specialists for pricing!

Customizable Options:

- Choose from a variety of tabletop thicknesses
- More than 20 drawer layout options
- Steel pegboard with hooks
- More than 100 color configurations
- Keyed Locks
- Lock Bar
- Casters
- Drawer Dividers
- Slide-in Vise or Versa-Mount

3BAY Workbench, 8ft (includes (2) 3-inch, (4) 6-inch, (2) 9-inch drawers, (1) Power Drawer, and receiver mount)	\$7,310.00
2BAY Workbench, 6ft (includes (2) 3-inch, (4) 6-inch, (2) 9-inch drawers, and (2) receiver mounts)	\$5,270.00
3BAYSD Single Drawer Workbench, 8ft (includes (2) 3-inch, (2) 6-inch, wire mesh bottom shelf, and receiver mount).	\$4,530.00
2BAYSD Single Drawer Workbench, 6ft (includes (2) 3-inch, (1) 6-inch, wire mesh bottom shelf, and (2) receiver mounts)	\$3,940.00

FABRICATION TABLES

- Badass Welding & Fabrication Tables are rock-solid and built with durability in mind.
- These tables feature a 1/2 inch thick steel top, beefy 4x4 legs, heavy duty welded frame, and a storage rack underneath.
- The two built-in receivers (4 on select models) accept the Versa-Mount tool mounting system to free up valuable tabletop and floor space.
- Standard tables come equipped with leveling feet, however optional heavy-duty casters, rated at 1200 lbs each, are available.
- Each table stands 36" tall and features a 4800 lb capacity.
- Call our Solution Specialists for customization options and pricing.



48" x 36" Welding and Fabrication Table (includes (4) tool receiver mounts, add \$300.00 for Casters)	\$2,230.00
72" x 36" Welding and Fabrication Table (includes (4) tool receiver mounts, add \$300.00 for Casters)	\$2,413.00
96" x 36" Welding and Fabrication Table (includes (2) tool receiver mounts, add \$300.00 for Casters)	\$2,770.00
96" x 48" Welding and Fabrication Table (includes (2) tool receiver mounts, add \$300.00 for Casters)	\$3,040.00

VERSA-MOUNT

WISE & GRINDER MOUNT



TT-RM-Combo

- Keeps work surface clear and eliminates the need for dedicated machine stands
- The table mount can be attached above or below your workbench or StrongHand Table/Rhino Cart, while the wall mount can be fitted to any vertical surface.
- Receivers include four jam bolts to produce a rock-solid fit for the tool mount
- Tool mount is constructed from 2 x 2, 3/16 inch wall square tubing, while the steel mounting plate is 3/8" thick and measures 8.5 x 9.5 inches
- Mounting plate features both 90 and 120 degree slots to accommodate a wide variety of tools, or you can drill your own holes as needed.



- RM-Combo (with Table Receiver) \$114.95
- RM3-Combo (with Wall Receiver) **SALE!** \$134.95
- Table Mount Receiver Only \$49.95
- Wall/Vertical Mount Receiver Only \$69.95
- Vise and Grinder Plate for Receiver Mount \$69.95

VERSA-MOUNT

SWIVELING PLATES & RECEIVERS

- The swiveling Universal Plate with Receiver Mount is great for mounting tools close at hand and free up bench or floor space
- The swiveling BuildPro Fixture Plate with Receiver Mount is a great way to fixture small parts and rotate for ease of welding.
- The swiveling Vise and Grinder Plate allows for repositioning tools to any desired angle
- Table mount receiver bolts directly on to StrongHand BuildPro Tables or Rhino Cart, but can also be mounted above, or below, any workbench.
- Choose from Table or Wall Mount



TT-RM4-GV-Combo



TT-RM4-UM-Combo



TT-RM4-BP-Combo

- RM4-GV-Combo Swiveling Vise/Grinder Plate (add \$20.00 for wall mount) . . \$184.95
- RM4-UM-Combo Swiveling Universal Plate (add \$20.00 for wall mount) . . . \$199.95
- RM4-BP-Combo Swiveling Fixture Plate (add \$20.00 for wall mount) \$329.95
- TT-RM4 Clamp Tube for Swivel Mount \$54.95
- VM-Block-Stud, Multi-Use Swivel Mounting Block \$49.95
- BP-Block-Stud BuildPro Swivel Mounting Block with Hardware \$39.95
- T52005-01 BuildPro Plate, 20 x 6-1/4 x 5/8 inch, Nitrided \$196.00

TRICK-TOOLS

TABLE TOP FIXTURE PLATE

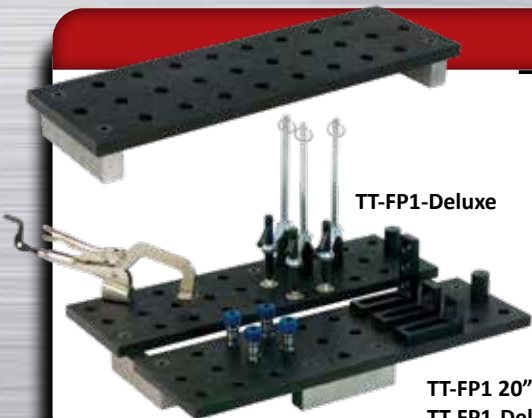

TT-FP1-Deluxe

- Use this fixture plate with the included riser blocks to fixture small parts where it is most convenient for you.
- Weighing a hefty 25 lbs and measuring 20 inches long x 6-1/4 inches wide, the 5/8 inch thick top plate features 30 fixturing holes in a 2 inch center to center pattern.
- The included riser blocks and hardware raise the plate 1-1/2 inches above the table surface and allow multiple plates to be linked together in any configuration.
- Riser blocks also serve as a great way to secure the fixture plate in a bench vise

- TT-FP1 20" Table Top Fixture Plate (includes 2 riser blocks and hardware) **SALE!** \$279.00
- TT-FP1-Deluxe (includes 2 fixture plates, 4 riser blocks, hardware, and 13 piece fixture kit) . . . \$830.50

WORKBENCHES & ORGANIZATION